



SUORITUSTASOILMOITUS

Nro: DoP-220440-EUS2 [FI]

ESSVE
GET IT DONE

Tuotetyypin yksilöllinen tunniste:

ESSVE Betoniruuvi EUS2 A4
ESSVE Betoniruuvi EUS2 HCR

Valmistaja:

ESSVE Produkter AB
BOX 7091
164 07 Kista
Sweden

Eurooppalainen tekninen arviointi (ETA)	Aiottu käyttötarkoitus (aiotut käyttötarkoitukset)	Ulkohalkaisija ja (poran) mitat [mm]	Tuotenro
ETA-22/0440 (2022-11-09)	<ul style="list-style-type: none">Single anchor or anchor groups for use in structural applications under static or quasi-static actions in cracked and uncracked concrete.Resistance to Fire for all dimensions and embedment depthsSeismic resistance C1 for certain embedment depths (see ETA Table 3)	7,5(6)	Kaikki tuoteryhmän tuotenumerot kuuluvat ETA:n piiriin.
		10,5(8)	
		12,5(10)	

Eurooppalainen tekninen arviointi (ETA)	Suoritustason pysyvyyden arvioinnissa ja varmentamisessa käytetty järjestelmä/käytetyt järjestelmät (AVCP)	Eurooppalainen arviointiasiakirja	Teknisestä arvioinnista vastaava laitos (TAB)	Ilmoitettu laitos/ilmoitetut laitokset (NB)
ETA-22/0440 (2022-11-09)	1	EAD 330232-01-0601, (2021-05)	Deutsches Institut für Bautechnik (DIBt)	2873 (FPC)



SUORITUSTASOILMOITUS

Nro: DoP-220440-EUS2 [FI]

ESSVE
GET IT DONE

Eurooppalainen tekninen arviointi (ETA)	Perusominaisuudet	Suoritustaso
ETA-22/0440 (2022-11-09)	Characteristic resistance to tension load (static and quasi-static loading)	ETA-22/0440 Annex B4, Annex C1, Annex C2
	Characteristic resistance to shear load (static and quasi-static loading)	ETA-22/0440 Annex C1, Annex C2
	Displacements (static and quasi-static loading)	ETA-22/0440 Annex C5
	Characteristic resistance and displacements for seismic performance category C1	ETA-22/0440 Annex C3
	Reaction to fire	Class A1
	Resistance to fire	ETA-22/0440 Annex C4
	Durability	ETA-22/0440 Annex B1

Edellä yksilöidyn tuotteen suoritustaso on ilmoitettujen suoritustasojen joukon mukainen. Tämä suoritustasoilmoitus on asetuksen (EU) N:o 305/2011 mukaisesti annettu edellä ilmoitetun valmistajan yksinomaisella vastuulla.

Valmistajan puolesta allekirjoittanut:

Viktor Bukowski
Product Manager – Concrete Fasteners

Kista 2023-08-07

[ETA attached as an appendix]

Approval body for construction products
and types of construction

Bautechnisches Prüfamt

An institution established by the Federal and
Laender Governments



European Technical Assessment

ETA-22/0440
of 9 November 2022

English translation prepared by DIBt - Original version in German language

General Part

Technical Assessment Body issuing the
European Technical Assessment:

Deutsches Institut für Bautechnik

Trade name of the construction product

ESSVE concrete screw EUS2 A4, EUS2 HCR

Product family
to which the construction product belongs

Mechanical fasteners for use in concrete

Manufacturer

ESSVE Produkter AB
Esbogatan 14
164 74 KISTA
SCHWEDEN

Manufacturing plant

ESSVE Plant no. 676

This European Technical Assessment
contains

19 pages including 3 annexes which form an integral part
of this assessment

This European Technical Assessment is
issued in accordance with Regulation (EU)
No 305/2011, on the basis of

EAD 330232-01-0601, Edition 05/2021

The European Technical Assessment is issued by the Technical Assessment Body in its official language. Translations of this European Technical Assessment in other languages shall fully correspond to the original issued document and shall be identified as such.

Communication of this European Technical Assessment, including transmission by electronic means, shall be in full. However, partial reproduction may only be made with the written consent of the issuing Technical Assessment Body. Any partial reproduction shall be identified as such.

This European Technical Assessment may be withdrawn by the issuing Technical Assessment Body, in particular pursuant to information by the Commission in accordance with Article 25(3) of Regulation (EU) No 305/2011.

Specific Part

1 Technical description of the product

The ESSVE concrete screw EUS2 A4, EUS2 HCR is an anchor in size 6, 8 and 10 mm made of stainless steel. The anchor is screwed into a predrilled cylindrical drill hole. The special thread of the anchor cuts an internal thread into the member while setting. The anchorage is characterised by mechanical interlock in the special thread.

Product and product description are given in Annex A.

2 Specification of the intended use in accordance with the applicable European Assessment Document

The performances given in Section 3 are only valid if the anchor is used in compliance with the specifications and conditions given in Annex B.

The verifications and assessment methods on which this European Technical Assessment is based lead to the assumption of a working life of the anchor of at least 50 years. The indications given on the working life cannot be interpreted as a guarantee given by the producer, but are to be regarded only as a means for choosing the right products in relation to the expected economically reasonable working life of the works.

3 Performance of the product and references to the methods used for its assessment

3.1 Mechanical resistance and stability (BWR 1)

Essential characteristic	Performance
Characteristic resistance to tension load (static and quasi-static loading)	See Annex B4, C1 and C2
Characteristic resistance to shear load (static and quasi-static loading)	See Annex C1 and C2
Displacements (static and quasi-static loading)	See Annex C5
Characteristic resistance and displacements for seismic performance categorie C1	See Annex C3

3.2 Safety in case of fire (BWR 2)

Essential characteristic	Performance
Reaction to fire	Class A1
Resistance to fire	See Annex C4

3.3 Aspects of durability linked with the Basic Works Requirements

Essential characteristic	Performance
Durability	See Annex B1

English translation prepared by DIBt

4 Assessment and verification of constancy of performance (AVCP) system applied, with reference to its legal base

In accordance with European Assessment Document EAD No. 330232-01-0601 the applicable European legal act is: [96/582/EC].

The system to be applied is: 1

5 Technical details necessary for the implementation of the AVCP system, as provided for in the applicable European Assessment Document

Technical details necessary for the implementation of the AVCP system are laid down in the control plan deposited at Deutsches Institut für Bautechnik.

Issued in Berlin on 9 November 2022 by Deutsches Institut für Bautechnik

Dipl.-Ing. Beatrix Wittstock
Head of Section

beglaubigt:
Tempel

Product in installed condition

ESSVE concrete screw EUS2 A4, EUS2 HCR

- stainless steel A4
- high corrosion resistant steel HCR

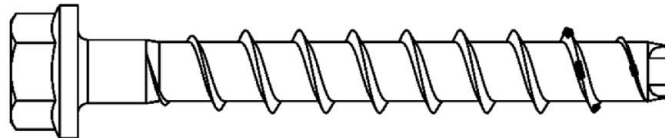

e.g. ESSVE concrete screw with hexagon head and fixture

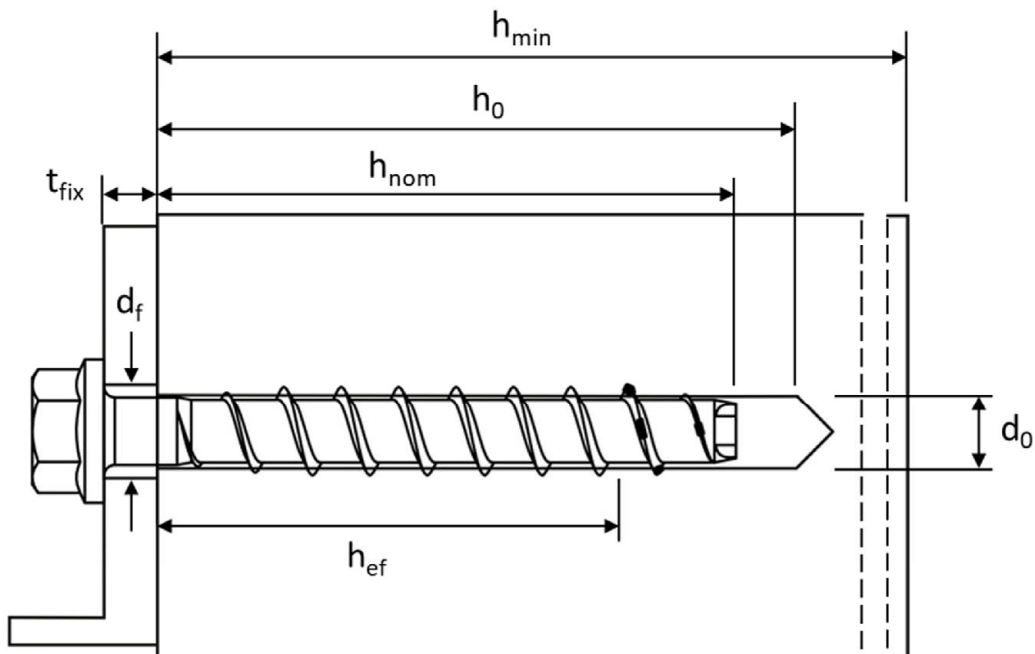

d_0 = nominal diameter of drill hole
 t_{fix} = thickness of fixture
 d_f = diameter of clearance hole

h_{min} = minimum thickness of member
 h_{nom} = nominal embedment depth
 h_0 = depth of drill hole
 h_{ef} = effective embedment depth

Top

Bottom

Filling washer (optional)
to fill annular gap

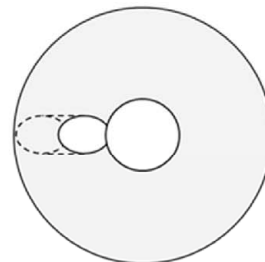
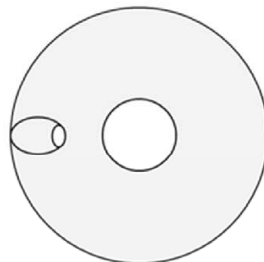

ESSVE concrete screw EUS2 A4, EUS2 HCR

Product description
Product in installed condition

Annex A1















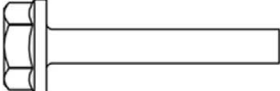

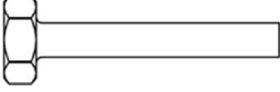

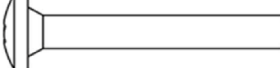

		Version with metric connection thread and hexagon drive e.g. EUS2-E 8x105 M10 SW7
		Version with washer and hexagon head e.g. EUS2-HF 8x80 SW13
		Version with washer, hexagon head and TORX drive e.g. EUS2-HF 8x80 SW13 TX40
		Version with hexagon head e.g. EUS2-H 8x80 SW13
		Version with countersunk head and TORX drive e.g. EUS2-C 8x80 TX40
		Version with pan head and TORX drive e.g. EUS2-PS 8x80 TX40
		Version with large pan head and TORX drive e.g. EUS2-PL 8x80 TX40
		Version with countersunk head and connection thread e.g. EUS2-E6 6x55 M8
		Version with hexagon drive and connection thread e.g. EUS2-E6 6x55 M8 SW10
		Version with internal thread and hexagon drive e.g. EUS2-I 6x55 M8/M10
ESSVE concrete screw EUS2 A4, EUS2 HCR		Annex A2
Product description Screw types		

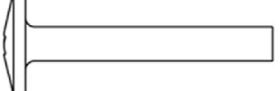
Table 1: Material

Part	Product name	Material		
all types	EUS2 A4	1.4401; 1.4404; 1.4571; 1.4578		
	EUS2 HCR	1.4529		
Part	Product name	Nominal characteristic steel		Rupture elongation A_5 [%]
		Yield strength f_{yk} [N/mm ²]	Ultimate strength f_{uk} [N/mm ²]	
all types	EUS2 A4	560	700	≤ 8
	EUS2 HCR			

Table 2: Dimensions

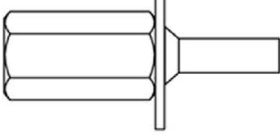
Anchor size			6			8			10		
Nominal embedment depth	h_{nom}	1 ¹⁾	2	3	1	2	3	1	2	3	
	[mm]	35	45	55	45	55	65	55	75	85	
Screw length	≤ L	[mm]	500								
Core diameter	d_k	[mm]	5,1			7,2			9,2		
Thread outer diameter	d_s	[mm]	7,6			10,5			12,5		
Thickness of filling washer	t_v	[mm]	5			5			5		

¹⁾ only for statically indeterminate non-structural systems (multiple use) according to EN 1992-4:2018, only in dry internal conditions

Marking:

EUS2 A4

Identification code: TSM
Screw size: 10
Screw length: 100
Material: A4

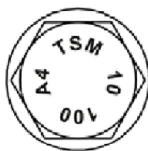

EUS2 HCR

Identification code: TSM
Screw size: 10
Screw length: 100
Material: HCR

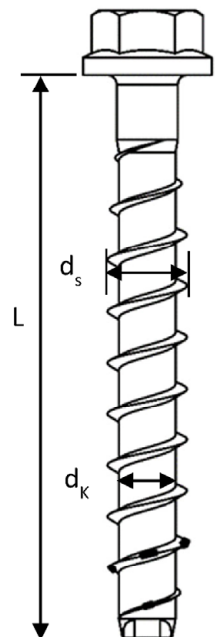

ESSVE concrete screw EUS2 A4, EUS2 HCR

Product description
Material, dimensions and markings

Annex A3

Specification of Intended use

Table 3: Anchorages subject to

EUS2 concrete screw size		6			8			10		
Nominal embedment depth	h_{nom}	h_{nom1} ¹⁾	h_{nom2}	h_{nom3}	h_{nom1}	h_{nom2}	h_{nom3}	h_{nom1}	h_{nom2}	h_{nom3}
	[mm]	35	45	55	45	55	65	55	75	85
Static and quasi-static loads		All sizes and all embedment depths								
Fire exposure										
C1 category - seismic		x	ok	ok	ok	x	ok	ok	x	ok

¹⁾ only for statically indeterminate non-structural systems (multiple use) according to EN 1992-4:2018, only in dry internal conditions

x no performance assessed

Base materials:

- Compacted reinforced and unreinforced concrete without fibers according to EN 206:2013.
- Strength classes C20/25 to C50/60 according to EN 206:2013.
- Cracked and uncracked concrete.

Use conditions (Environmental conditions):

- Concrete screws subject to dry internal conditions: all screw types.
- For all other conditions corresponding to corrosion resistance classes CRC according to EN 1993-1-4:2006 + A1:2015
 - Stainless steel according to Annex A3, screw with marking A4: CRC III
 - High corrosion resistant steel according to Annex A3, screw with marking HCR: CRC V

ESSVE concrete screw EUS2 A4, EUS2 HCR

Intended use
Specification

Annex B1

Specification of Intended use - continuation

Design:

- Anchorages are to be designed under the responsibility of an engineer experienced in anchorages and concrete work.
- Verifiable calculation notes and drawings are to be prepared taking account of the loads to be anchored. The position of the anchor is indicated on the design drawings (e.g. position of the anchor relative to reinforcement or to supports, etc.).
- Anchorages are designed according to EN 1992-4:2018 and EOTA Technical Report TR 055, Edition February 2018.

The design for shear load according to EN 1992-4:2018, Section 6.2.2 applies for all specified diameters d_f of clearance hole in the fixture in Annex B3, Table 4.

Installation:

- Hammer drilling or hollow drilling. Hollow drilling only for size 8-10.
- Anchor installation carried out by appropriately qualified personnel and under the supervision of the person responsible for technical matters on site.
- In case of aborted hole: new drilling must be drilled at a minimum distance of twice the depth of aborted hole or closer, if the aborted hole is filled with high strength mortar and only if the hole is not in the direction of the oblique tensile or shear load.
- After installation further turning of the anchor must not be possible. The head of the anchor is supported in the fixture and is not damaged.
- The borehole may be filled with injection mortar CF-T 300V or ATA 2004C.
- Adjustability according to Annex B6 for sizes 6-10.
- Cleaning of borehole is not necessary, if using a hollow drill.

ESSVE concrete screw EUS2 A4, EUS2 HCR

Intended use
Specification continuation

Annex B2

Table 4: Installation parameters

EUS2 concrete screw size			6			8			10		
Nominal embedment depth	h_{nom}	$h_{nom1}^{1)}$	h_{nom2}	h_{nom3}	h_{nom1}	h_{nom2}	h_{nom3}	h_{nom1}	h_{nom2}	h_{nom3}	
	[mm]	35	45	55	45	55	65	55	75	85	
Nominal drill hole diameter	d_0	[mm]	6			8			10		
Cutting diameter of drill bit	$d_{cut} \leq$	[mm]	6,40			8,45			10,45		
Depth of drill hole	$h_0 \geq$	[mm]	40	50	60	55	65	75	65	85	95
Clearance hole diameter	$d_f \leq$	[mm]	8			12			14		
Installation torque (version with connection thread)	T_{inst}	[Nm]	10			20			40		
Torque impact screw driver	[-]	Max. torque according to manufacturer's instructions									
		160			300			450			

¹⁾ only for statically indeterminate non-structural systems (multiple use) according to EN 1992-4:2018, only in dry internal conditions

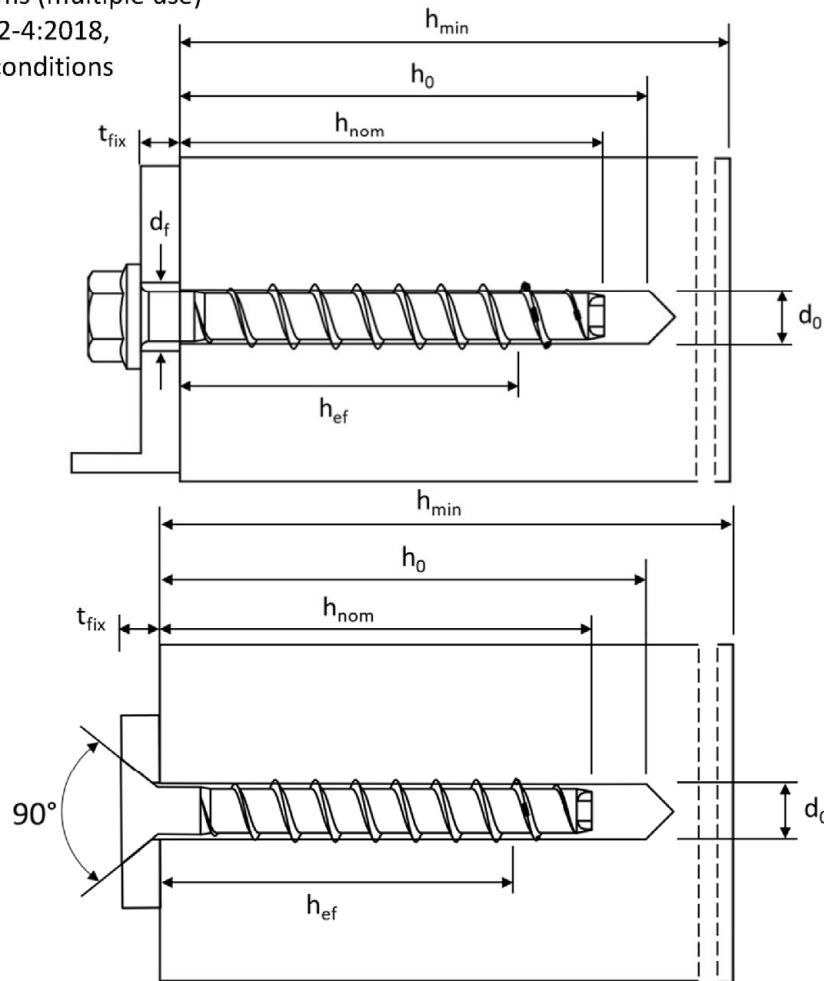

ESSVE concrete screw EUS2 A4, EUS2 HCR

Intended use
Installation parameters

Annex B3

Table 5: Minimum thickness of member, minimum edge distance and minimum spacing

EUS2 concrete screw size			6			8			10		
Nominal embedment depth	h_{nom}	$h_{nom1}^{1)}$	h_{nom2}	h_{nom3}	h_{nom1}	h_{nom2}	h_{nom3}	h_{nom1}	h_{nom2}	h_{nom3}	
	[mm]	35	45	55	45	55	65	55	75	85	
Minimum thickness of member	h_{min}	[mm]	80	80	100	80	100	120	100	130	130
Minimum edge distance	c_{min}	[mm]	35	35	35	35	35	35	40	40	40
Minimum spacing	s_{min}	[mm]	35	35	35	35	35	35	40	40	40

¹⁾ only for statically indeterminate non-structural systems (multiple use) according to EN 1992-4:2018, only in dry internal conditions

ESSVE concrete screw EUS2 A4, EUS2 HCR

Intended use

Minimum thickness of member, minimum edge distance and minimum spacing

Annex B4

Installation Instructions

1

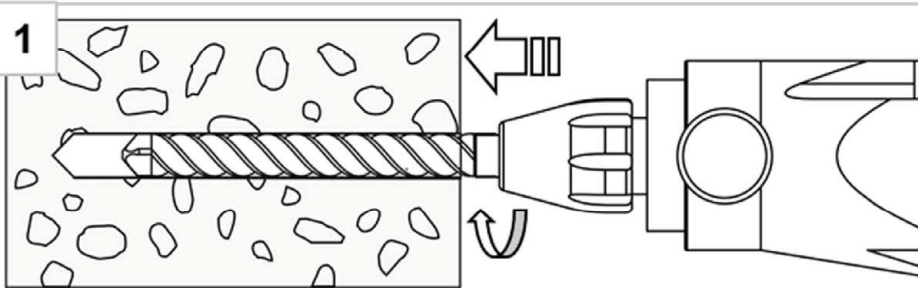

Create hammer drilled or hollow drilled borehole

2

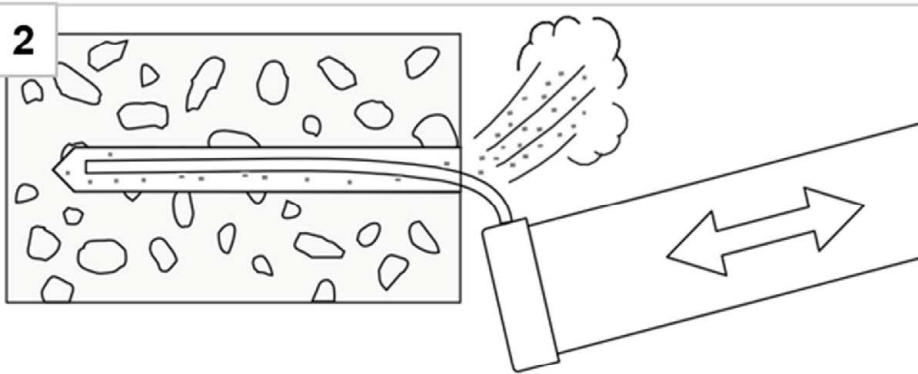

Remove drill dust by vacuuming or blowing of

3

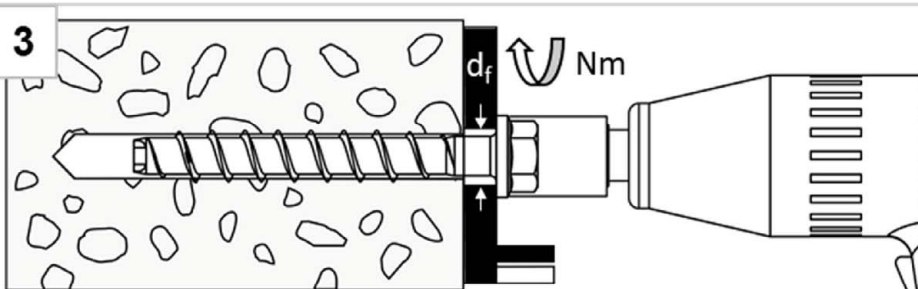

Install with torque impact screw driver or torque wrench

4

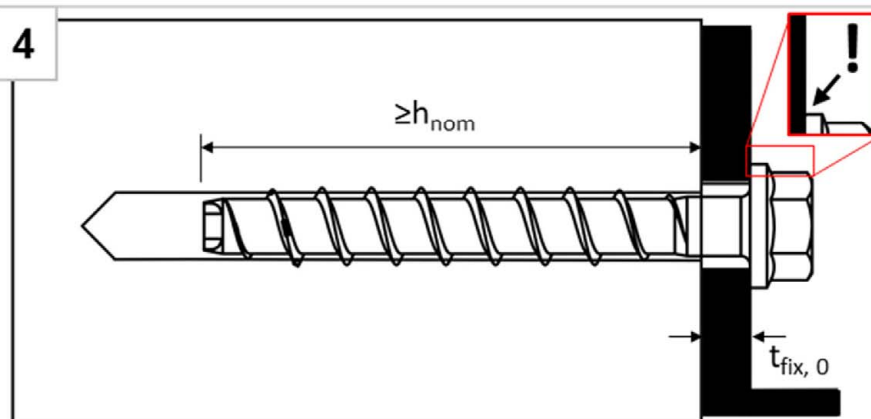

The head must be undamaged and in contact with the fixture

For screw size 6 with $h_{nom} = 35\text{mm}$, installation only with impact screw drivers.

ESSVE concrete screw EUS2 A4, EUS2 HCR

Intended use
Installation instructions

Annex B5

Installation Instructions – Adjustment

1. Adjustment

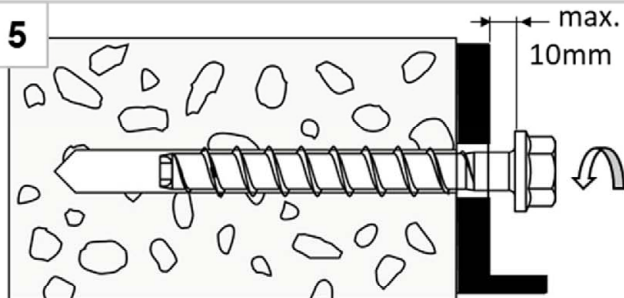

Screw may be untightened maximum 10mm

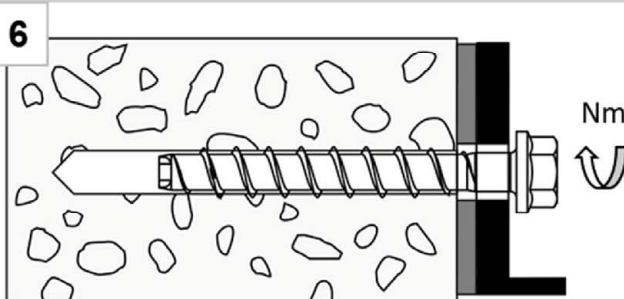

After adjustment, tighten the screw again

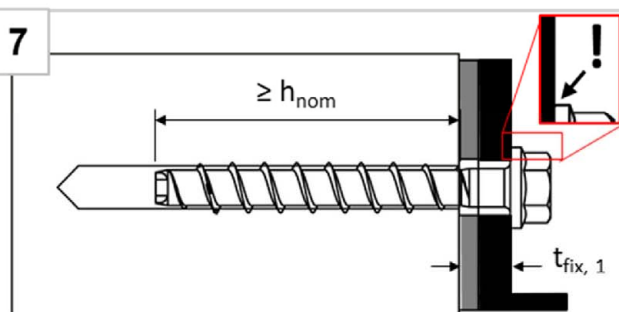

The head must be undamaged and in contact with the fixture

2. Adjustment

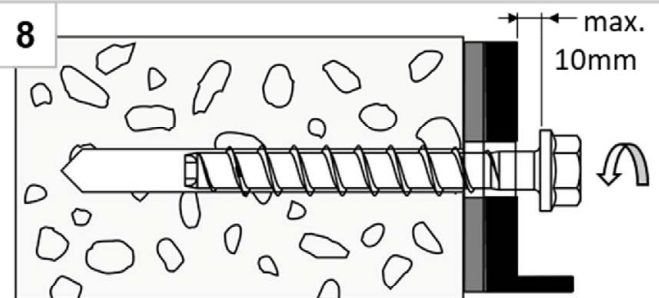

Screw may be untightened maximum 10mm

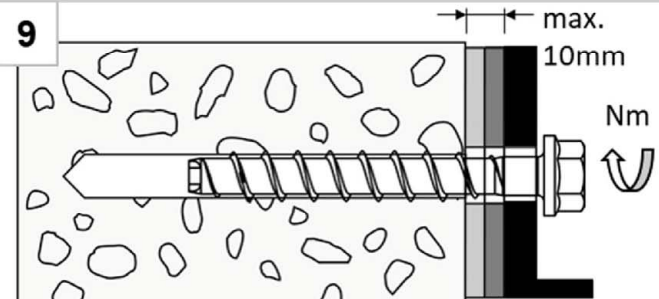

After adjustment, tighten the screw again

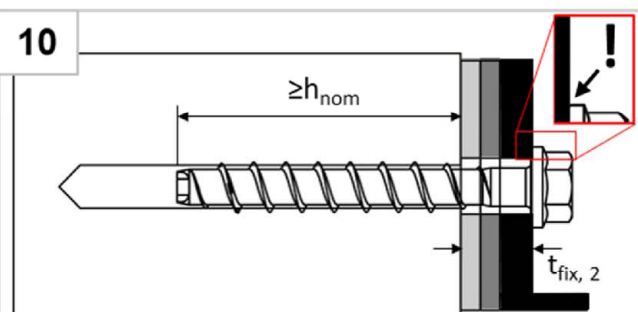

The head must be undamaged and in contact with the fixture

Note:

The fastener can be adjusted maximum two times. The total allowed thickness of shims added during the adjustment process is 10mm. The final embedment depth after adjustment process must be larger or equal than h_{nom} .

ESSVE concrete screw EUS2 A4, EUS2 HCR

Intended use
Installation instructions - Adjustment

Annex B6

Installation Instructions – Filling annular gap

Positioning of fixture and filling washer

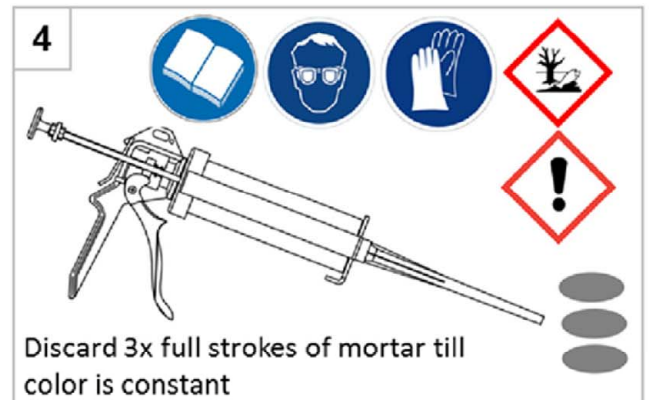
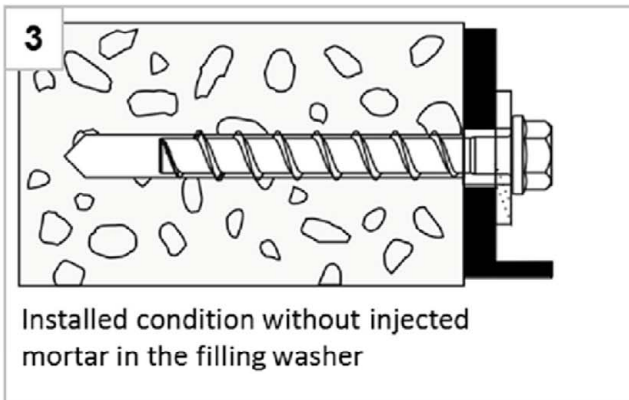
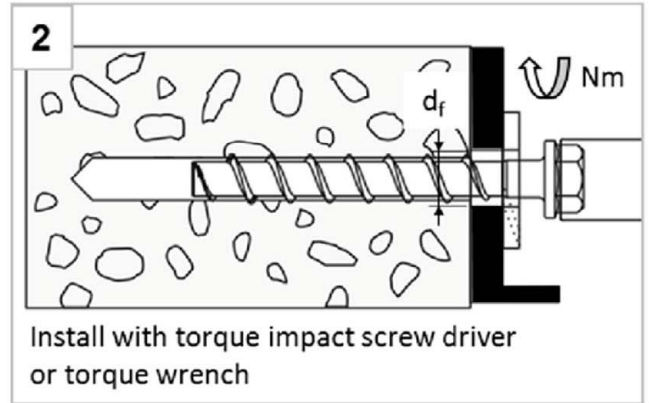
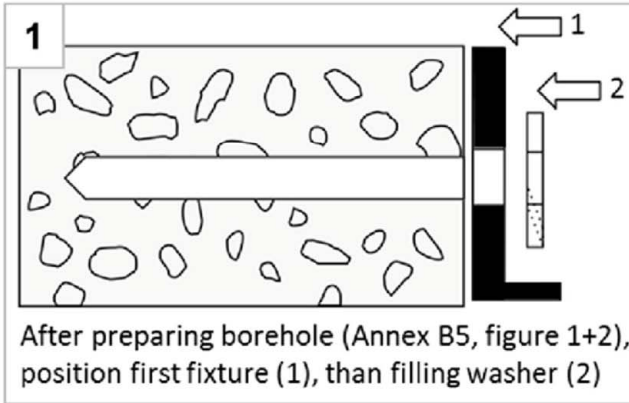

Filling the annular gap

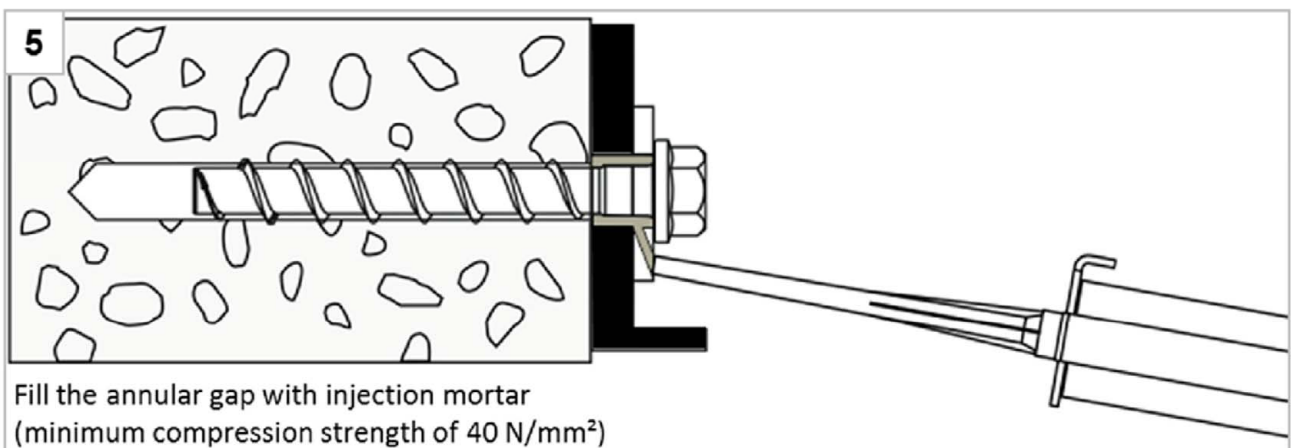

Note:

For seismic loading the installation with filled and without filled annular gap is approved. Differences in performance can be found in Annex C3.

ESSVE concrete screw EUS2 A4, EUS2 HCR

Intended use
Installation instructions – Filling annular gap

Annex B7

Table 6: Characteristic values for static and quasi-static loading

EUS2 concrete screw size		6			8			10			
Nominal embedment depth	h_{nom}	$h_{nom1}^{1)}$	h_{nom2}	h_{nom3}	h_{nom1}	h_{nom2}	h_{nom3}	h_{nom1}	h_{nom2}	h_{nom3}	
	[mm]	35	45	55	45	55	65	55	75	85	
Steel failure for tension and shear loading											
Characteristic tension load	$N_{RK,s}$	[kN]	14,0			27,0			45,0		
Partial factor	$\gamma_{Ms,N}$	[-]	1,5								
Characteristic shear load	$V_{RK,s}^0$	[kN]	7,0			13,5	17,0	22,5	34,0		
Partial factor	$\gamma_{Ms,V}$	[-]	1,25								
Ductility factor	k_7	[-]	0,8								
Characteristic bending load	$M_{RK,s}^0$	[Nm]	10,9			26,0			56,0		
Pull-out failure in uncracked concrete											
Characteristic tension load C20/25	$N_{RK,p}$	[kN]	3,5 ¹⁾	4,0	8,5	9,0	12,0	17,0	11,0	19,0	25,0
Increasing factor for $N_{RK,p} = N_{RK,p(C20/25)} \cdot \Psi_c$	C25/30	Ψ_c	[-]	1,08	1,12	1,09	1,12	1,07	1,12		
	C30/37			1,15	1,22	1,17	1,22	1,13	1,22		
	C40/50			1,27	1,41	1,30	1,41	1,23	1,41		
	C50/60			1,38	1,58	1,42	1,58	1,32	1,58		
Pull-out failure in cracked concrete											
Characteristic tension load C20/25	$N_{RK,p}$	[kN]	2,5 ¹⁾	1,5	3,0	3,0	5,5	8,0	6,0	13,0	17,0
Increasing factor for $N_{RK,p} = N_{RK,p(C20/25)} \cdot \Psi_c$	C25/30	Ψ_c	[-]	1,10	1,08	1,12	1,12		1,12	1,09	
	C30/37			1,18	1,15	1,22	1,22		1,22	1,17	
	C40/50			1,32	1,27	1,41	1,41		1,41	1,31	
	C50/60			1,45	1,38	1,58	1,58		1,58	1,43	
¹⁾ only for statically indeterminate non-structural systems (multiple use) according to EN 1992-4:2018, only in dry internal conditions											
ESSVE concrete screw EUS2 A4, EUS2 HCR									Annex C1		
Performances Characteristic values for static and quasi-static loading											

Table 7: Characteristic values for static and quasi-static loading continuation

EUS2 concrete screw size			6			8			10			
Nominal embedment depth	h_{nom}	$h_{nom1}^{1)}$	h_{nom2}	h_{nom3}	h_{nom1}	h_{nom2}	h_{nom3}	h_{nom1}	h_{nom2}	h_{nom3}		
	[mm]	35	45	55	45	55	65	55	75	85		
Concrete failure: concrete cone failure and splitting failure												
Effective embedment depth	h_{ef}	[mm]	25	34	42	32	41	49	40	57	65	
k-factor	cracked	k_{cr}	7,7									
	uncracked	k_{ucr}	11,0									
Concrete cone failure	spacing	$S_{cr,N}$	$3 \times h_{ef}$									
	edge distance	$C_{cr,N}$	$1,5 \times h_{ef}$									
Splitting failure case 1	resistance	$N_{Rk,sp}^0$	[kN]	3,5 ¹⁾	4,0	8,5	9,0	12,0	17,0	11,0	19,0	25,0
	spacing	$S_{cr,sp}$	[mm]	120	160	240	200	240	290	230	280	320
	edge distance	$C_{cr,sp}$	[mm]	60	80	120	100	120	145	115	140	160
Splitting failure case 2	resistance	$N_{Rk,sp}^0$	[kN]	2 ²⁾	2,5	5,5	5,5	8,0	11,0	7,0	15,0	20,0
	spacing	$S_{cr,sp}$	[mm]	2 ²⁾	116	168	128	164	196	160	224	260
	edge distance	$C_{cr,sp}$	[mm]	2 ²⁾	58	84	64	82	98	80	114	130
Pry-out failure												
Factor for pry-out failure	k_g	[-]	1,0	1,6	2,1	2,8	2,5					
Installation factor	γ_{inst}	[-]	1,0									
Concrete edge failure												
Effective length in concrete	l_f	[mm]	35	45	55	45	55	65	55	75	85	
Nominal outer diameter of screw	d_{nom}	[mm]	6			8			10			
¹⁾ only for statically indeterminate non-structural systems (multiple use) according to EN 1992-4:2018, only in dry internal conditions ²⁾ no performance assessed												
ESSVE concrete screw EUS2 A4, EUS2 HCR										Annex C2		
Performances Characteristic values for static and quasi-static loading continuation												

Table 8: Seismic category C1 – Characteristic load values (only EUS2-HF, EUS2-H, EUS2-C, EUS2-E, EUS2-E6¹⁾, EUS2-PS, EUS2-PL and EUS2-I¹⁾)

EUS2 concrete screw size			6		8		10	
Nominal embedment depth	h_{nom}		h_{nom2}	h_{nom3}	h_{nom1}	h_{nom3}	h_{nom1}	h_{nom3}
	[mm]		45	55	45	65	55	85
Steel failure for tension and shear load (version EUS2-HF, -H, -C, -E, -E6 ¹⁾ , -PL, -PS and -I ¹⁾)								
Characteristic tension load	$N_{Rk,s,C1}$	[kN]	14,0		27,0		45,0	
Partial factor	$\gamma_{Ms,N}$	[-]	1,5					
Characteristic shear load EUS2-HF, -H, -E, -PS, -PL	$V_{Rk,s,C1}$	[kN]	3,5	4,0	8,0	10,0	14,0	16,0
Characteristic shear load EUS2-C	$V_{Rk,s,C1}$	[kN]	2,5	²⁾	4,5	7,0	14,0	10,0
Partial factor	$\gamma_{Ms,V}$	[-]	1,25					
Without filling of the annular gap ³⁾	α_{gap}	[-]	0,5					
With filling of the annular gap ⁴⁾	α_{gap}	[-]	1,0					
Pull-out failure (version EUS2-HF, -H, -C, -E, -E6 ¹⁾ , -PS, -PL and -I ¹⁾)								
Characteristic tension load in cracked concrete C20/25	$N_{Rk,p,C1}$	[kN]	1,5	3,0	3,0	8,5	6,0	17,0
Concrete cone failure (version EUS2-HF, -H, -C, -E, -E6 ¹⁾ , -PS, -PL and -I ¹⁾)								
Effective embedment depth	h_{ef}	[mm]	34	42	32	49	40	65
Edge distance	$c_{cr,N}$	[mm]	1,5 x h_{ef}					
Spacing	$s_{cr,N}$	[mm]	3 x h_{ef}					
Installation safety factor	γ_{inst}	[-]	1,0					
Concrete pry-out failure (version EUS2-HF, -H, -C, -E, -PS and -PL)								
Factor for pry-out failure	k_8	[-]	1,6	2,1	2,8	2,5		
Concrete edge failure (version EUS2-HF, -H, -C, -E, -PS and -PL)								
Effective length in concrete	l_f	[mm]	45	55	45	65	55	85
Nominal outer diameter of screw	d_{nom}	[mm]	6		8		10	

¹⁾ only tension load

²⁾ no performance assessed

³⁾ without filling of the annular gap according to annex B5

⁴⁾ with filling of the annular gap according to annex B7

ESSVE concrete screw EUS2 A4, EUS2 HCR

Performances
Seismic category C1 – Characteristic load values

Annex C3

Table 9: Fire exposure – characteristic values of resistance

EUS2 concrete screw size				6			8			10			
Nominal embedment depth				h_{nom}	1 ¹⁾	2	3	1	2	3	1	2	3
				[mm]	35	45	55	45	55	65	55	75	85
Steel failure for tension and shear load													
characteristic Resistance	R30	$N_{Rk,s,fi30}$	[kN]	0,9			2,4			4,4			
	R60	$N_{Rk,s,fi60}$	[kN]	0,8			1,7			3,3			
	R90	$N_{Rk,s,fi90}$	[kN]	0,6			1,1			2,3			
	R120	$N_{Rk,s,fi120}$	[kN]	0,4			0,7			1,7			
	R30	$V_{Rk,s,fi30}$	[kN]	0,9			2,4			4,4			
	R60	$V_{Rk,s,fi60}$	[kN]	0,8			1,7			3,3			
	R90	$V_{Rk,s,fi90}$	[kN]	0,6			1,1			2,3			
	R120	$V_{Rk,s,fi120}$	[kN]	0,4			0,7			1,7			
	R30	$M^0_{Rk,s,fi30}$	[Nm]	0,7			2,4			5,9			
	R60	$M^0_{Rk,s,fi60}$	[Nm]	0,6			1,8			4,5			
	R90	$M^0_{Rk,s,fi90}$	[Nm]	0,5			1,2			3,0			
	R120	$M^0_{Rk,s,fi120}$	[Nm]	0,3			0,9			2,3			
Pull-out failure													
characteristic Resistance	R30-90	$N_{Rk,p,fi}$	[kN]	0,6	0,4	0,8	0,8	1,4	2,0	1,5	3,3	4,3	
	R120	$N_{Rk,p,fi}$	[kN]	0,5	0,3	0,6	0,6	1,1	1,6	1,2	2,6	3,4	
Concrete cone failure													
characteristic Resistance	R30-90	$N^0_{Rk,c,fi}$	[kN]	0,5	1,2	2,0	1,0	1,9	2,9	1,7	4,2	5,9	
	R120	$N^0_{Rk,c,fi}$	[kN]	0,4	0,9	1,6	0,8	1,5	2,3	1,4	3,4	4,7	
Edge distance													
R30 - R120		$C_{cr,fi}$	[mm]	2 x h_{ef}									
In case of fire attack from more than one side, the minimum edge distance shall be ≥ 300 mm.													
Spacing													
R30 - R120		$S_{cr,fi}$	[mm]	4 x h_{ef}									
Pry-out failure													
R30 - R120		k_g	[-]	1,0	1,6	2,1	2,8	2,5					
The anchorage depth has to be increased for wet concrete by at least 30 mm compared to the given value.													
¹⁾ only for statically indeterminate non-structural systems (multiple use) according to EN 1992-4:2018, only in dry internal conditions													
ESSVE concrete screw EUS2 A4, EUS2 HCR											Annex C4		
Performances Fire exposure – characteristic values of resistance													

Table 10: Displacements under static and quasi-static tension load

EUS2 concrete screw size				6			8			10		
Nominal embedment depth			h_{nom}	h_{nom2}	h_{nom3}	h_{nom1}	h_{nom2}	h_{nom3}	h_{nom1}	h_{nom2}	h_{nom3}	
			[mm]	45	55	45	55	65	55	75	85	
Cracked concrete	tension load	N	[kN]	0,72	1,45	1,63	2,74	4,06	3,04	6,22	8,46	
	displacement	δ_{N0}	[mm]	0,19	0,27	0,27	0,53	0,45	0,26	0,58	0,61	
		$\delta_{N\infty}$	[mm]	0,55	0,84	0,49	0,66	0,61	0,69	0,92	1,1	
Uncracked concrete	tension load	N	[kN]	2,11	4,07	4,24	5,97	8,03	5,42	9,17	12,28	
	displacement	δ_{N0}	[mm]	0,42	0,43	0,33	0,49	0,58	0,84	0,62	0,79	
		$\delta_{N\infty}$	[mm]	0,42	0,43	0,58			0,79			

Table 11: Displacements under static and quasi-static shear load

EUS2 concrete screw size				6			8			10		
Nominal embedment depth			h_{nom}	h_{nom2}	h_{nom3}	h_{nom1}	h_{nom2}	h_{nom3}	h_{nom1}	h_{nom2}	h_{nom3}	
			[mm]	45	55	45	55	65	55	75	85	
Cracked and uncracked concrete	shear load	V	[kN]	3,3			8,6			16,2		
	displacement	δ_{V0}	[mm]	1,55			2,7			2,7		
		$\delta_{V\infty}$	[mm]	3,1			4,1			4,3		

ESSVE concrete screw EUS2 A4, EUS2 HCR

Performances
Displacements under static and quasi-static loads

Annex C5