



# YTELSESERKLÆRING

Nr: 18-ONE [NO]

**ESSVE**  
GET IT DONE

## Varetypens unike identifikasjonskode:

Ankermasse ESSVE ONE

Ankermasse ESSVE ONE-ICE

## Produsent:

ESSVE Produkter AB

BOX 7091

164 07 Kista

Sweden

info@essve.se

| Europeisk teknisk bedømmelse (ETA) | Tilsiktet bruksområde                                                                                                                                                                                                                                                                                                                                                                                                                                                                       | Artikkelnummer   |
|------------------------------------|---------------------------------------------------------------------------------------------------------------------------------------------------------------------------------------------------------------------------------------------------------------------------------------------------------------------------------------------------------------------------------------------------------------------------------------------------------------------------------------------|------------------|
| ETA-18/0617 (2019-12-11)           | Bonded anchor consisting of a cartridge with injection mortar ESSVE ONE, or ONE-ICE and a steel element for use in: <ul style="list-style-type: none"><li>cracked concrete strength classes C20/25 to C50/60.</li><li>uncracked concrete strength classes C20/25 to C50/60.</li></ul>                                                                                                                                                                                                       | 302334<br>302336 |
| ETA-18/0642 (2018-10-08)           | Bonded anchor consisting of a cartridge with injection mortar ESSVE ONE, ONE-ICE and a steel element for use in: <ul style="list-style-type: none"><li>Masonry bricks defined in the ETA</li><li>For other bricks in solid masonry and in hollow or perforated masonry, the characteristic resistance of the anchor may be determined by job site tests according to EOTA Technical Report TR 053 under consideration of the <math>\beta</math>-factor to ETA Annex C1, Table C1.</li></ul> | 302334<br>302336 |

| Europeisk teknisk bedømmelse (ETA) | System for vurdering og verifikasjon av byggevarers ytelser (AVCP) | Europeisk bedømmelsesdokument       | Teknisk bedømmelsesorgan (TAB)           | Teknisk(e) kontrollorgan (NB) |
|------------------------------------|--------------------------------------------------------------------|-------------------------------------|------------------------------------------|-------------------------------|
| ETA-18/0617 (2019-12-11)           | 1                                                                  | EAD 330499-01-0601, (2018-08 draft) | DEUTSCHES INSTITUT FÜR BAUTECHNIK (DIBt) | 1343 (FPC)                    |
| ETA-18/0642 (2018-10-08)           | 1                                                                  | EAD 330076-00-0604, (2014-07)       | DEUTSCHES INSTITUT FÜR BAUTECHNIK (DIBt) | 1343 (FPC)                    |



# YTELSESERKLÆRING

Nr: 18-ONE [NO]

# ESSVE

GET IT DONE

| Europeisk teknisk bedømmelse (ETA) | Dimensjon & Materiale                                                              | Egenskap                                                                        | Ytelse               |
|------------------------------------|------------------------------------------------------------------------------------|---------------------------------------------------------------------------------|----------------------|
| ETA-18/0617 (2019-12-11)           | Threaded rod M8 to M30<br>Rebar Ø8 to Ø32<br>Internal threaded rod IG-M6 to IG-M20 | Characteristic resistance to tension load (static and quasi-static loading)     | Annex C1, C2, C4, C6 |
|                                    |                                                                                    | Characteristic resistance to shear load (static and quasi-static loading)       | Annex C1, C3, C5, C7 |
|                                    |                                                                                    | Displacements under short term and long-term loading                            | Annex C8 – C10       |
|                                    |                                                                                    | Durability                                                                      | Annex B1             |
|                                    | Threaded rod M8 to M30 (except hot-dipped)<br>Rebar Ø8 to Ø32                      | Characteristic resistance and displacements for seismic performance category C1 | Annex C2, C3, C6, C7 |
|                                    | -                                                                                  | Characteristic resistance and displacements for seismic performance category C2 | NPD                  |
| -                                  | Content, emission and/or release of dangerous substances                           | NPD                                                                             |                      |
| ETA-18/0642 (2018-10-08)           | Threaded rod M8 to M16<br>IG-M6 to IG-M10                                          | Characteristic values for resistance                                            | Annex C6 – C45       |
|                                    |                                                                                    | Reduction $\beta$ -factors for job-site testing                                 | Annex C1             |
|                                    |                                                                                    | Displacements                                                                   | Annex C5 – C45       |
|                                    |                                                                                    | Durability                                                                      | Annex B1             |
|                                    |                                                                                    | Reaction to fire                                                                | Class A1             |
|                                    | -                                                                                  | Content, emission and/or release of dangerous substances                        | NPD                  |

Ytelser for denne byggevaren som er anført ovenfor, er i overensstemmelse med de angitte ytelsene. Denne ytelseserklæringen er utarbeidet i overensstemmelse med forordning (EU) nr. 305/2011 under produsentens eneansvar, som anført ovenfor.

Underskrevet for produsenten og på dennes vegne:

Viktor Bukowski  
Product Developer/Technical expert – Fasteners

Kista 2020-01-20

[ETA's attached as appendixes]

Approval body for construction products  
and types of construction

Bautechnisches Prüfamt

An institution established by the Federal and  
Laender Governments



## European Technical Assessment

**ETA-18/0617**  
**of 11 December 2019**

English translation prepared by DIBt - Original version in German language

### General Part

Technical Assessment Body issuing the  
European Technical Assessment:

Deutsches Institut für Bautechnik

Trade name of the construction product

Injection system ESSVE ONE or  
ESSVE ONE-ICE for concrete

Product family  
to which the construction product belongs

Bonded fastener for use in concrete

Manufacturer

ESSVE Produkter AB  
Esbogatan 14  
164 74 KISTA  
SCHWEDEN

Manufacturing plant

ESSVE Plant No. 671

This European Technical Assessment  
contains

31 pages including 3 annexes which form an integral part  
of this assessment

This European Technical Assessment is  
issued in accordance with Regulation (EU)  
No 305/2011, on the basis of

EAD 330499-01-0601

This version replaces

ETA-18/0617 issued on 15 February 2019

The European Technical Assessment is issued by the Technical Assessment Body in its official language. Translations of this European Technical Assessment in other languages shall fully correspond to the original issued document and shall be identified as such.

Communication of this European Technical Assessment, including transmission by electronic means, shall be in full. However, partial reproduction may only be made with the written consent of the issuing Technical Assessment Body. Any partial reproduction shall be identified as such.

This European Technical Assessment may be withdrawn by the issuing Technical Assessment Body, in particular pursuant to information by the Commission in accordance with Article 25(3) of Regulation (EU) No 305/2011.

**Specific Part**

**1 Technical description of the product**

The "Injection System ESSVE ONE, ESSVE ONE-ICE for concrete" is a bonded anchor consisting of a cartridge with injection ESSVE ONE or ESSVE ONE-ICE and a steel element. The steel element consists of a commercial threaded rod with washer and hexagon nut in the range of M8 to M30 or reinforcing bar in the range of Ø 8 to Ø 32 mm or an internal threaded anchor rod IG-M6 to IG-M20.

The steel element is placed into a drilled hole filled with injection mortar and is anchored via the bond between metal part, injection mortar and concrete.

The product description is given in Annex A.

**2 Specification of the intended use in accordance with the applicable European Assessment Document**

The performances given in Section 3 are only valid if the anchor is used in compliance with the specifications and conditions given in Annex B.

The verifications and assessment methods on which this European Technical Assessment is based lead to the assumption of a working life of the anchor of at least 50 years. The indications given on the working life cannot be interpreted as a guarantee given by the producer, but are to be regarded only as a means for choosing the right products in relation to the expected economically reasonable working life of the works.

**3 Performance of the product and references to the methods used for its assessment**

**3.1 Mechanical resistance and stability (BWR 1)**

| Essential characteristic                                                          | Performance                    |
|-----------------------------------------------------------------------------------|--------------------------------|
| Characteristic resistance to tension load (static and quasi-static loading)       | See Annex C 1 to C 3, C 5, C 7 |
| Characteristic resistance to shear load (static and quasi-static loading)         | See Annex C1, C 4, C 6, C 8    |
| Displacements (static and quasi-static loading)                                   | See Annex C 9 to C 11          |
| Characteristic resistance and displacements for seismic performance categories C1 | See Annex C 12 to C 16         |
| Characteristic resistance and displacements for seismic performance categories C2 | No performance assessed        |
| Durability                                                                        | See Annex B 1                  |

**3.2 Hygiene, health and the environment (BWR 3)**

| Essential characteristic                                 | Performance             |
|----------------------------------------------------------|-------------------------|
| Content, emission and/or release of dangerous substances | No performance assessed |

**4 Assessment and verification of constancy of performance (AVCP) system applied, with reference to its legal base**

In accordance with the European Assessment Document EAD 330499-01-0601 the applicable European legal act is: [96/582/EC].

The system to be applied is: 1

**5 Technical details necessary for the implementation of the AVCP system, as provided for in the applicable European Assessment Document**

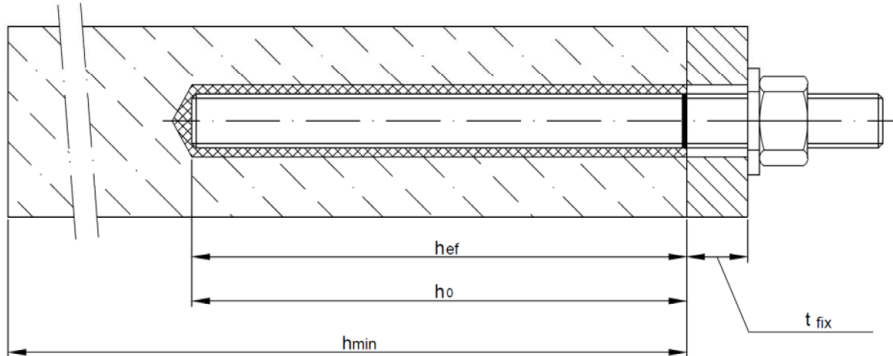
Technical details necessary for the implementation of the AVCP system are laid down in the control plan deposited at Deutsches Institut für Bautechnik.

Issued in Berlin on 11 December 2019 by Deutsches Institut für Bautechnik

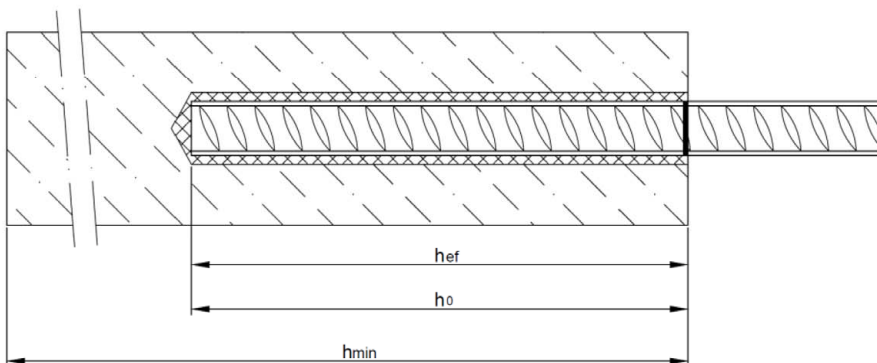
Dr.-Ing. Lars Eckfeldt  
p.p. Head of Department

*beglaubigt:*  
Baderschneider

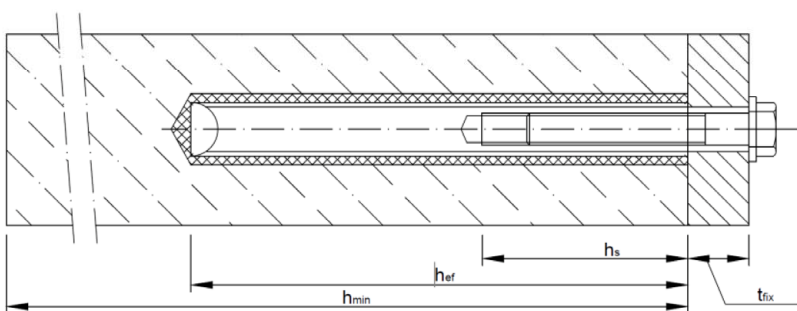
### Installation threaded rod M8 up to M30



### Installation reinforcing bar $\varnothing 8$ up to $\varnothing 32$



### Installation internal threaded anchor rod IG-M6 up to IG-M20



- $t_{fix}$  = thickness of fixture
- $h_{ef}$  = effective anchorage depth
- $h_0$  = depth of drill hole
- $h_{min}$  = minimum thickness of member

Injection System ESSVE ONE, ESSVE ONE-ICE for concrete

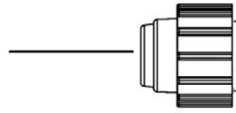
Product description  
Installed condition

Annex A 1

**Cartridge: ESSVE ONE or ESSVE ONE-ICE**

**150 ml, 280 ml, 300 ml up to 333 ml and 380 ml up to 420 ml cartridge (Type: coaxial)**

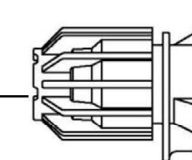
Sealing/Screw cap



Imprint: ESSVE ONE or ESSVE ONE-ICE, processing notes, charge-code, shelf life, storage temperature, hazard-code, curing- and processing time (depending on the temperature), with as well as without travel scale

**235 ml, 345 ml up to 360 ml and 825 ml cartridge (Type: "side-by-side")**

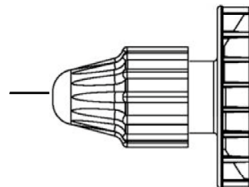
Sealing/Screw cap



Imprint: ESSVE ONE or ESSVE ONE-ICE, processing notes, charge-code, shelf life, storage temperature, hazard-code, curing- and processing time (depending on the temperature), with as well as without travel scale

**165 ml and 300 ml cartridge (Type: "foil tube")**

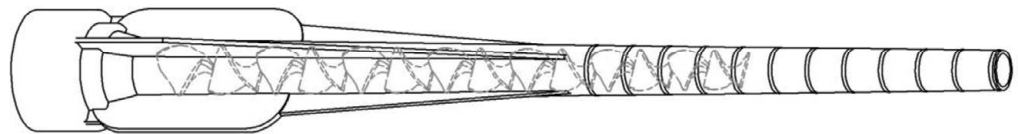
Sealing/Screw cap



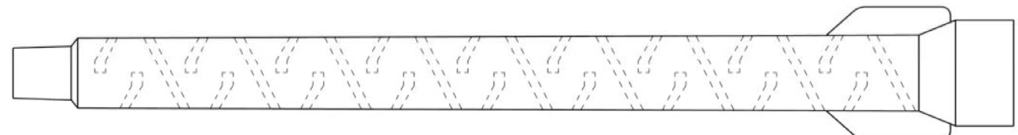
Imprint: ESSVE ONE or ESSVE ONE-ICE, processing notes, charge-code, shelf life, storage temperature, hazard-code, curing- and processing time (depending on the temperature), with as well as without travel scale

**Static Mixer**

CRW 14W



TAH 18W



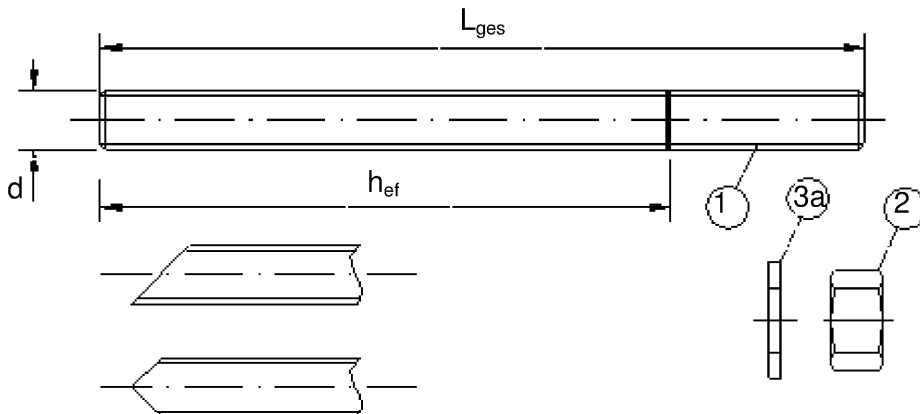
Injection System ESSVE ONE, ESSVE ONE-ICE for concrete

**Product description**  
Injection system

**Annex A 2**



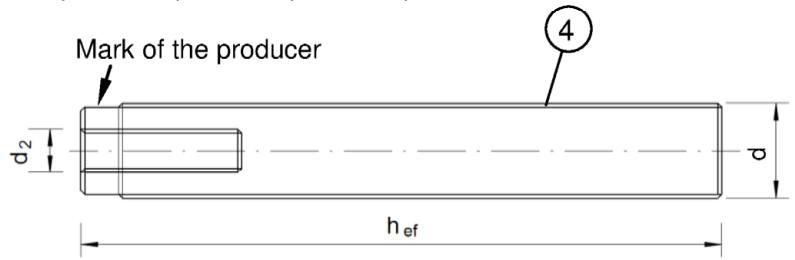
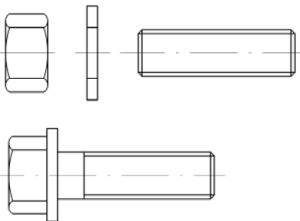
**Threaded rod M8, M10, M12, M16, M20, M24, M27, M30 with washer and hexagon nut**






- Commercial standard threaded rod with:
- Materials, dimensions and mechanical properties acc. Table A1
  - Inspection certificate 3.1 acc. to EN 10204:2004
  - Marking of embedment depth

**Internal threaded anchor rod IG-M6, IG-M8, IG-M10, IG-M12, IG-M16, IG-M20**

Threaded rod or screw

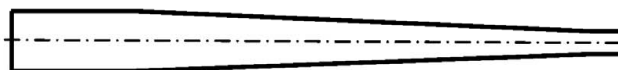
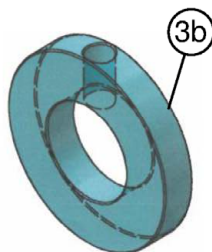


Marking: e.g.  M8

-  Marking Internal thread
-  Mark

- M8 Thread size (Internal thread)
- A4 additional mark for stainless steel
- HCR additional mark for high-corrosion resistance steel

**Filling washer and mixer reduction nozzle for filling the annular gap between anchor rod and fixture**



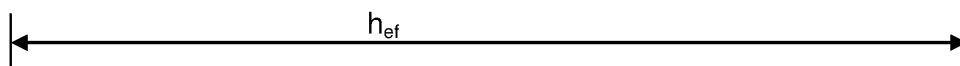
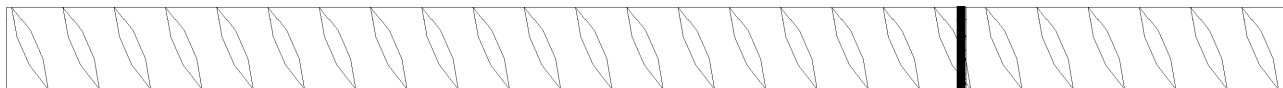
Injection System ESSVE ONE, ESSVE ONE-ICE for concrete

**Product description**  
Threaded rod, internal threaded rod and filling washer

**Annex A 3**

| <b>Table A1: Materials</b>                                                                                                                                                                                                    |                                              |                                                                                                                                                                                                                                                                                                                       |                                 |                                   |                               |                |
|-------------------------------------------------------------------------------------------------------------------------------------------------------------------------------------------------------------------------------|----------------------------------------------|-----------------------------------------------------------------------------------------------------------------------------------------------------------------------------------------------------------------------------------------------------------------------------------------------------------------------|---------------------------------|-----------------------------------|-------------------------------|----------------|
| <b>Part</b>                                                                                                                                                                                                                   | <b>Designation</b>                           | <b>Material</b>                                                                                                                                                                                                                                                                                                       |                                 |                                   |                               |                |
| <b>Steel, zinc plated</b> (Steel acc. to EN 10087:1998 or EN 10263:2001)                                                                                                                                                      |                                              |                                                                                                                                                                                                                                                                                                                       |                                 |                                   |                               |                |
| - zinc plated $\geq 5 \mu\text{m}$ acc. to EN ISO 4042:1999 or                                                                                                                                                                |                                              |                                                                                                                                                                                                                                                                                                                       |                                 |                                   |                               |                |
| - hot-dip galvanised $\geq 40 \mu\text{m}$ acc. to EN ISO 1461:2009 and EN ISO 10684:2004+AC:2009 or                                                                                                                          |                                              |                                                                                                                                                                                                                                                                                                                       |                                 |                                   |                               |                |
| - sherardized $\geq 45 \mu\text{m}$ acc. to EN ISO 17668:2016                                                                                                                                                                 |                                              |                                                                                                                                                                                                                                                                                                                       |                                 |                                   |                               |                |
| 1                                                                                                                                                                                                                             | Threaded rod                                 | Property class                                                                                                                                                                                                                                                                                                        | Characteristic tensile strength | Characteristic yield strength     | Elongation at fracture        |                |
|                                                                                                                                                                                                                               |                                              | acc. to EN ISO 898-1:2013                                                                                                                                                                                                                                                                                             | 4.6                             | $f_{uk} = 400 \text{ N/mm}^2$     | $f_{yk} = 240 \text{ N/mm}^2$ | $A_5 > 8\%$    |
|                                                                                                                                                                                                                               |                                              |                                                                                                                                                                                                                                                                                                                       | 4.8                             | $f_{uk} = 400 \text{ N/mm}^2$     | $f_{yk} = 320 \text{ N/mm}^2$ | $A_5 > 8\%$    |
|                                                                                                                                                                                                                               |                                              |                                                                                                                                                                                                                                                                                                                       | 5.6                             | $f_{uk} = 500 \text{ N/mm}^2$     | $f_{yk} = 300 \text{ N/mm}^2$ | $A_5 > 8\%$    |
|                                                                                                                                                                                                                               |                                              |                                                                                                                                                                                                                                                                                                                       | 5.8                             | $f_{uk} = 500 \text{ N/mm}^2$     | $f_{yk} = 400 \text{ N/mm}^2$ | $A_5 > 8\%$    |
| 8.8                                                                                                                                                                                                                           | $f_{uk} = 800 \text{ N/mm}^2$                | $f_{yk} = 640 \text{ N/mm}^2$                                                                                                                                                                                                                                                                                         | $A_5 \geq 8\%$                  |                                   |                               |                |
| 2                                                                                                                                                                                                                             | Hexagon nut                                  | acc. to EN ISO 898-2:2012                                                                                                                                                                                                                                                                                             | 4                               | for threaded rod class 4.6 or 4.8 |                               |                |
|                                                                                                                                                                                                                               |                                              |                                                                                                                                                                                                                                                                                                                       | 5                               | for threaded rod class 5.6 or 5.8 |                               |                |
|                                                                                                                                                                                                                               |                                              |                                                                                                                                                                                                                                                                                                                       | 8                               | for threaded rod class 8.8        |                               |                |
| 3a                                                                                                                                                                                                                            | Washer                                       | Steel, zinc plated, hot-dip galvanised or sherardized (e.g.: EN ISO 887:2006, EN ISO 7089:2000, EN ISO 7093:2000 or EN ISO 7094:2000)                                                                                                                                                                                 |                                 |                                   |                               |                |
| 3b                                                                                                                                                                                                                            | Filling washer                               | Steel, zinc plated, hot-dip galvanised or sherardized                                                                                                                                                                                                                                                                 |                                 |                                   |                               |                |
| 4                                                                                                                                                                                                                             | Internal threaded anchor rod                 | Property class                                                                                                                                                                                                                                                                                                        | Characteristic tensile strength | Characteristic yield strength     | Elongation at fracture        |                |
|                                                                                                                                                                                                                               |                                              | acc. to EN ISO 898-1:2013                                                                                                                                                                                                                                                                                             | 5.8                             | $f_{uk} = 500 \text{ N/mm}^2$     | $f_{yk} = 400 \text{ N/mm}^2$ | $A_5 > 8\%$    |
|                                                                                                                                                                                                                               |                                              |                                                                                                                                                                                                                                                                                                                       | 8.8                             | $f_{uk} = 800 \text{ N/mm}^2$     | $f_{yk} = 640 \text{ N/mm}^2$ | $A_5 > 8\%$    |
| <b>Stainless steel A2</b> (Material 1.4301 / 1.4307 / 1.4311 / 1.4567 or 1.4541, acc. to EN 10088-1:2014)                                                                                                                     |                                              |                                                                                                                                                                                                                                                                                                                       |                                 |                                   |                               |                |
| <b>Stainless steel A4</b> (Material 1.4401 / 1.4404 / 1.4571 / 1.4362 or 1.4578, acc. to EN 10088-1:2014)                                                                                                                     |                                              |                                                                                                                                                                                                                                                                                                                       |                                 |                                   |                               |                |
| <b>High corrosion resistance steel</b> (Material 1.4529 or 1.4565, acc. to EN 10088-1: 2014)                                                                                                                                  |                                              |                                                                                                                                                                                                                                                                                                                       |                                 |                                   |                               |                |
| 1                                                                                                                                                                                                                             | Threaded rod <sup>1)3)</sup>                 | Property class                                                                                                                                                                                                                                                                                                        | Characteristic tensile strength | Characteristic yield strength     | Elongation at fracture        |                |
|                                                                                                                                                                                                                               |                                              | acc. to EN ISO 3506-1:2009                                                                                                                                                                                                                                                                                            | 50                              | $f_{uk} = 500 \text{ N/mm}^2$     | $f_{yk} = 210 \text{ N/mm}^2$ | $A_5 \geq 8\%$ |
|                                                                                                                                                                                                                               |                                              |                                                                                                                                                                                                                                                                                                                       | 70                              | $f_{uk} = 700 \text{ N/mm}^2$     | $f_{yk} = 450 \text{ N/mm}^2$ | $A_5 \geq 8\%$ |
| 2                                                                                                                                                                                                                             | Hexagon nut <sup>1)3)</sup>                  | acc. to EN ISO 3506-1:2009                                                                                                                                                                                                                                                                                            | 50                              | for threaded rod class 50         |                               |                |
|                                                                                                                                                                                                                               |                                              |                                                                                                                                                                                                                                                                                                                       | 70                              | for threaded rod class 70         |                               |                |
|                                                                                                                                                                                                                               |                                              |                                                                                                                                                                                                                                                                                                                       | 80                              | for threaded rod class 80         |                               |                |
| 3a                                                                                                                                                                                                                            | Washer                                       | A2: Material 1.4301 / 1.4307 / 1.4311 / 1.4567 or 1.4541, acc. to EN 10088-1:2014<br>A4: Material 1.4401 / 1.4404 / 1.4571 / 1.4362 or 1.4578, acc. to EN 10088-1:2014<br>HCR: Material 1.4529 or 1.4565, acc. to EN 10088-1: 2014<br>(e.g.: EN ISO 887:2006, EN ISO 7089:2000, EN ISO 7093:2000 or EN ISO 7094:2000) |                                 |                                   |                               |                |
| 3b                                                                                                                                                                                                                            | Filling washer                               | Stainless steel A4, High corrosion resistance steel                                                                                                                                                                                                                                                                   |                                 |                                   |                               |                |
| 4                                                                                                                                                                                                                             | Internal threaded anchor rod <sup>1)2)</sup> | Property class                                                                                                                                                                                                                                                                                                        | Characteristic tensile strength | Characteristic yield strength     | Elongation at fracture        |                |
|                                                                                                                                                                                                                               |                                              | acc. to EN ISO 3506-1:2009                                                                                                                                                                                                                                                                                            | 50                              | $f_{uk} = 500 \text{ N/mm}^2$     | $f_{yk} = 210 \text{ N/mm}^2$ | $A_5 > 8\%$    |
|                                                                                                                                                                                                                               |                                              |                                                                                                                                                                                                                                                                                                                       | 70                              | $f_{uk} = 700 \text{ N/mm}^2$     | $f_{yk} = 450 \text{ N/mm}^2$ | $A_5 > 8\%$    |
| <sup>1)</sup> Property class 70 for threaded rods up to M24 and Internal threaded anchor rods up to IG-M16,<br><sup>2)</sup> for IG-M20 only property class 50<br><sup>3)</sup> Property class 80 only for stainless steel A4 |                                              |                                                                                                                                                                                                                                                                                                                       |                                 |                                   |                               |                |
| <b>Injection System ESSVE ONE, ESSVE ONE-ICE for concrete</b>                                                                                                                                                                 |                                              |                                                                                                                                                                                                                                                                                                                       |                                 |                                   | <b>Annex A 4</b>              |                |
| <b>Product description</b><br>Materials threaded rod and internal threaded rod                                                                                                                                                |                                              |                                                                                                                                                                                                                                                                                                                       |                                 |                                   |                               |                |

**Reinforcing bar  $\varnothing 8, \varnothing 10, \varnothing 12, \varnothing 14, \varnothing 16, \varnothing 20, \varnothing 25, \varnothing 28, \varnothing 32$**



- Minimum value of related rip area  $f_{R,min}$  according to EN 1992-1-1:2004+AC:2010
- Rib height of the bar shall be in the range  $0,05d \leq h \leq 0,07d$   
(d: Nominal diameter of the bar; h: Rip height of the bar)

**Table A2: Materials**

| Part                    | Designation                                | Material                                                                                                                               |
|-------------------------|--------------------------------------------|----------------------------------------------------------------------------------------------------------------------------------------|
| <b>Reinforcing bars</b> |                                            |                                                                                                                                        |
| 1                       | Rebar<br>EN 1992-1-1:2004+AC:2010, Annex C | Bars and de-coiled rods class B or C<br>$f_{yk}$ and k according to NDP or NCL of EN 1992-1-1/NA<br>$f_{uk} = f_{tk} = k \cdot f_{yk}$ |

**Injection System ESSVE ONE, ESSVE ONE-ICE for concrete**

**Product description**  
Materials reinforcing bar

**Annex A 5**

### Specifications of intended use

#### Anchorage subject to:

- Static and quasi-static loads: M8 to M30, Rebar Ø8 to Ø32, IG-M6 to IG-M20.
- Seismic action for Performance Category C1: M8 to M30, Rebar Ø8 to Ø32.

#### Base materials:

- Compacted, reinforced or unreinforced normal weight concrete without fibres according to EN 206:2013 + A1:2016.
- Strength classes C20/25 to C50/60 according to EN 206:2013 + A1:2016.
- Non-cracked concrete: M8 to M30, Rebar Ø8 to Ø32, IG-M6 to IG-M20.
- Cracked concrete: M8 to M30, Rebar Ø8 to Ø32, IG-M6 to IG-M20.

#### Temperature Range:

- I: - 40 °C to +40 °C (max long term temperature +24 °C and max short term temperature +40 °C)
- II: - 40 °C to +80 °C (max long term temperature +50 °C and max short term temperature +80 °C)
- III: - 40 °C to +120 °C (max long term temperature +72 °C and max short term temperature +120 °C)

#### Use conditions (Environmental conditions):

- Structures subject to dry internal conditions (all materials).
- For all other conditions according to EN 1993-1-4:2006+A1:2015 corresponding to corrosion resistance class:
  - Stainless steel Stahl A2 according to Annex A 4, Table A1: CRC II
  - Stainless steel Stahl A4 according to Annex A 4, Table A1: CRC III
  - High corrosion resistance steel HCR according to Annex A 4, Table A1: CRC V

#### Design:

- Verifiable calculation notes and drawings are prepared taking account of the loads to be anchored. The position of the anchor is indicated on the design drawings (e. g. position of the anchor relative to reinforcement or to supports, etc.).
- Anchorages are designed under the responsibility of an engineer experienced in anchorages and concrete work.
- The anchorages are designed in accordance to EN 1992-4:2018 and Technical Report TR055, Edition February 2018

#### Installation:

- Dry or wet concrete: M8 to M30, Rebar Ø8 to Ø32, IG-M6 to IG-M20.
- Flooded holes (not sea water): M8 to M16, Rebar Ø8 to Ø16, IG-M6 to IG-M10.
- Hole drilling by hammer (HD), hollow (HDB) or compressed air drill mode (CD).
- Overhead installation allowed.
- Anchor installation carried out by appropriately qualified personnel and under the supervision of the person responsible for technical matters of the site.
- The injection mortar is assessed for installation at minimum concrete temperature of -10°C resp. -20°C, where subsequently the temperature in the concrete does not rise at a rapid rate, i.e. from the minimum installation temperature to 24°C within a 12-hour period.

|                                                        |                  |
|--------------------------------------------------------|------------------|
| Injection System ESSVE ONE, ESSVE ONE-ICE for concrete | <b>Annex B 1</b> |
| Intended Use Specifications                            |                  |

| Anchor size                               |                     | M8                                           | M10 | M12 | M16             | M20 | M24 | M27 | M30 |
|-------------------------------------------|---------------------|----------------------------------------------|-----|-----|-----------------|-----|-----|-----|-----|
| Outer diameter of anchor                  | $d_{nom}$ [mm] =    | 8                                            | 10  | 12  | 16              | 20  | 24  | 27  | 30  |
| Nominal drill hole diameter               | $d_0$ [mm] =        | 10                                           | 12  | 14  | 18              | 24  | 28  | 32  | 35  |
| Effective embedment depth                 | $h_{ef,min}$ [mm] = | 60                                           | 60  | 70  | 80              | 90  | 96  | 108 | 120 |
|                                           | $h_{ef,max}$ [mm] = | 160                                          | 200 | 240 | 320             | 400 | 480 | 540 | 600 |
| Diameter of clearance hole in the fixture | $d_f$ [mm] ≤        | 9                                            | 12  | 14  | 18              | 22  | 26  | 30  | 33  |
| Diameter of steel brush                   | $d_b$ [mm] ≥        | 12                                           | 14  | 16  | 20              | 26  | 30  | 34  | 37  |
| Maximum torque moment                     | $T_{inst}$ [Nm] ≤   | 10                                           | 20  | 40  | 80              | 120 | 160 | 180 | 200 |
| Minimum thickness of member               | $h_{min}$ [mm]      | $h_{ef} + 30 \text{ mm} \geq 100 \text{ mm}$ |     |     | $h_{ef} + 2d_0$ |     |     |     |     |
| Minimum spacing                           | $s_{min}$ [mm]      | 40                                           | 50  | 60  | 80              | 100 | 120 | 135 | 150 |
| Minimum edge distance                     | $c_{min}$ [mm]      | 40                                           | 50  | 60  | 80              | 100 | 120 | 135 | 150 |




| Rebar size                  |                     | Ø 8                                          | Ø 10 | Ø 12 | Ø 14            | Ø 16 | Ø 20 | Ø 25 | Ø 28 | Ø 32 |
|-----------------------------|---------------------|----------------------------------------------|------|------|-----------------|------|------|------|------|------|
| Outer diameter of anchor    | $d_{nom}$ [mm] =    | 8                                            | 10   | 12   | 14              | 16   | 20   | 25   | 28   | 32   |
| Nominal drill hole diameter | $d_0$ [mm] =        | 12                                           | 14   | 16   | 18              | 20   | 24   | 32   | 35   | 40   |
| Effective embedment depth   | $h_{ef,min}$ [mm] = | 60                                           | 60   | 70   | 75              | 80   | 90   | 100  | 112  | 128  |
|                             | $h_{ef,max}$ [mm] = | 160                                          | 200  | 240  | 280             | 320  | 400  | 500  | 580  | 640  |
| Diameter of steel brush     | $d_b$ [mm] ≥        | 14                                           | 16   | 18   | 20              | 22   | 26   | 34   | 37   | 41,5 |
| Minimum thickness of member | $h_{min}$ [mm]      | $h_{ef} + 30 \text{ mm} \geq 100 \text{ mm}$ |      |      | $h_{ef} + 2d_0$ |      |      |      |      |      |
| Minimum spacing             | $s_{min}$ [mm]      | 40                                           | 50   | 60   | 70              | 80   | 100  | 125  | 140  | 160  |
| Minimum edge distance       | $c_{min}$ [mm]      | 40                                           | 50   | 60   | 70              | 80   | 100  | 125  | 140  | 160  |

| Size internal threaded anchor rod         |                     | IG-M6                                        | IG-M8 | IG-M10 | IG-M12          | IG-M16 | IG-M20 |
|-------------------------------------------|---------------------|----------------------------------------------|-------|--------|-----------------|--------|--------|
| Internal diameter of anchor               | $d_2$ [mm] =        | 6                                            | 8     | 10     | 12              | 16     | 20     |
| Outer diameter of anchor <sup>1)</sup>    | $d_{nom}$ [mm] =    | 10                                           | 12    | 16     | 20              | 24     | 30     |
| Nominal drill hole diameter               | $d_0$ [mm] =        | 12                                           | 14    | 18     | 22              | 28     | 35     |
| Effective embedment depth                 | $h_{ef,min}$ [mm] = | 60                                           | 70    | 80     | 90              | 96     | 120    |
|                                           | $h_{ef,max}$ [mm] = | 200                                          | 240   | 320    | 400             | 480    | 600    |
| Diameter of clearance hole in the fixture | $d_f$ [mm] =        | 7                                            | 9     | 12     | 14              | 18     | 22     |
| Maximum torque moment                     | $T_{inst}$ [Nm] ≤   | 10                                           | 10    | 20     | 40              | 60     | 100    |
| Thread engagement length min/max          | $l_{IG}$ [mm] =     | 8/20                                         | 8/20  | 10/25  | 12/30           | 16/32  | 20/40  |
| Minimum thickness of member               | $h_{min}$ [mm]      | $h_{ef} + 30 \text{ mm} \geq 100 \text{ mm}$ |       |        | $h_{ef} + 2d_0$ |        |        |
| Minimum spacing                           | $s_{min}$ [mm]      | 50                                           | 60    | 80     | 100             | 120    | 150    |
| Minimum edge distance                     | $c_{min}$ [mm]      | 50                                           | 60    | 80     | 100             | 120    | 150    |

<sup>1)</sup> With metric threads according to EN 1993-1-8:2005+AC:2009

|                                                               |                  |
|---------------------------------------------------------------|------------------|
| <b>Injection System ESSVE ONE, ESSVE ONE-ICE for concrete</b> | <b>Annex B 2</b> |
| <b>Intended Use</b><br>Installation parameters                |                  |

**Table B4: Parameter cleaning and setting tools**

| Threaded Rod | Rebar | Internal threaded Anchor rod | $d_0$<br>Drill bit - $\varnothing$<br>HD, HDB, CA | $d_b$<br>Brush - $\varnothing$ |      | $d_{b,min}$<br>min.<br>Brush - $\varnothing$ | Piston plug             | Installation direction and use of piston plug                                       |                                                                                     |                                                                                     |
|--------------|-------|------------------------------|---------------------------------------------------|--------------------------------|------|----------------------------------------------|-------------------------|-------------------------------------------------------------------------------------|-------------------------------------------------------------------------------------|-------------------------------------------------------------------------------------|
|              |       |                              |                                                   | [mm]                           | [mm] |                                              |                         |  |  |  |
| [mm]         | [mm]  | [mm]                         | [mm]                                              |                                | [mm] | [mm]                                         |                         |                                                                                     |                                                                                     |                                                                                     |
| M8           |       |                              | 10                                                | RBT10                          | 12   | 10,5                                         | No piston plug required |                                                                                     |                                                                                     |                                                                                     |
| M10          | 8     | IG-M6                        | 12                                                | RBT12                          | 14   | 12,5                                         |                         |                                                                                     |                                                                                     |                                                                                     |
| M12          | 10    | IG-M8                        | 14                                                | RBT14                          | 16   | 14,5                                         |                         |                                                                                     |                                                                                     |                                                                                     |
|              | 12    |                              | 16                                                | RBT16                          | 18   | 16,5                                         |                         |                                                                                     |                                                                                     |                                                                                     |
| M16          | 14    | IG-M10                       | 18                                                | RBT18                          | 20   | 18,5                                         | VS18                    | $h_{ef} > 250$ mm                                                                   | $h_{ef} > 250$ mm                                                                   | all                                                                                 |
|              | 16    |                              | 20                                                | RBT20                          | 22   | 20,5                                         | VS20                    |                                                                                     |                                                                                     |                                                                                     |
| M20          | 20    | IG-M12                       | 24                                                | RBT24                          | 26   | 24,5                                         | VS24                    |                                                                                     |                                                                                     |                                                                                     |
| M24          |       | IG-M16                       | 28                                                | RBT28                          | 30   | 28,5                                         | VS28                    |                                                                                     |                                                                                     |                                                                                     |
| M27          | 25    |                              | 32                                                | RBT32                          | 34   | 32,5                                         | VS32                    |                                                                                     |                                                                                     |                                                                                     |
| M30          | 28    | IG-M20                       | 35                                                | RBT35                          | 37   | 35,5                                         | VS35                    |                                                                                     |                                                                                     |                                                                                     |
|              | 32    |                              | 40                                                | RBT40                          | 41,5 | 40,5                                         | VS40                    |                                                                                     |                                                                                     |                                                                                     |



**MAC - Hand pump (volume 750 ml)**  
Drill bit diameter ( $d_0$ ): 10 mm to 20 mm  
Drill hole depth ( $h_0$ ):  $< 10 d_{nom}$   
Only in non-cracked concrete



**CAC - Rec. compressed air tool (min 6 bar)**  
Drill bit diameter ( $d_0$ ): all diameters



**Piston plug for overhead or horizontal installation VS**  
Drill bit diameter ( $d_0$ ): 18 mm to 40 mm

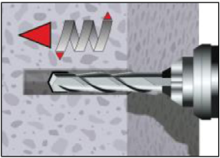
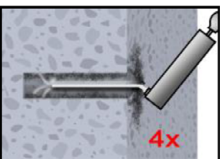
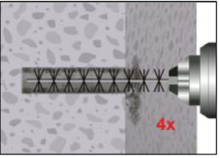
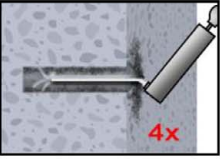
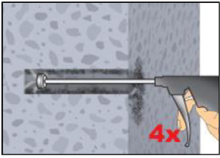
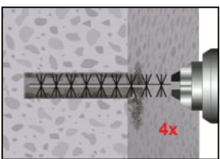
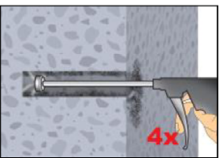


**Steel brush RBT**  
Drill bit diameter ( $d_0$ ): all diameters

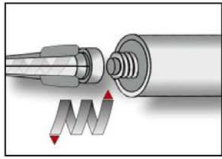
Injection System ESSVE ONE, ESSVE ONE-ICE for concrete

**Intended Use**  
Cleaning and setting tools

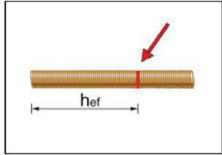
**Annex B 3**

| Installation instructions                                                                                                                                                                                                                                                                              |                                                                                                                                                                                                                                                                                                                                                                                               |
|--------------------------------------------------------------------------------------------------------------------------------------------------------------------------------------------------------------------------------------------------------------------------------------------------------|-----------------------------------------------------------------------------------------------------------------------------------------------------------------------------------------------------------------------------------------------------------------------------------------------------------------------------------------------------------------------------------------------|
| Drilling of the bore hole                                                                                                                                                                                                                                                                              |                                                                                                                                                                                                                                                                                                                                                                                               |
|                                                                                                                                                                                                                       | <p>1. Drill with hammer drill a hole into the base material to the size and embedment depth required by the selected anchor (Table B1, B2, or B3), with hammer (HD), hollow (HDB) or compressed air (CD) drilling. The use of a hollow drill bit is only in combination with a sufficient vacuum permitted.<br/>In case of aborted drill hole: The drill hole shall be filled with mortar</p> |
| <b>Attention! Standing water in the bore hole must be removed before cleaning.</b>                                                                                                                                                                                                                     |                                                                                                                                                                                                                                                                                                                                                                                               |
| MAC: Cleaning for bore hole diameter $d_0 \leq 20\text{mm}$ and bore hole depth $h_0 \leq 10d_{\text{nom}}$ (uncracked concrete only!)                                                                                                                                                                 |                                                                                                                                                                                                                                                                                                                                                                                               |
|                                                                                                                                                                                                                       | 2a. Starting from the bottom or back of the bore hole, blow the hole clean by a hand pump <sup>1)</sup> (Annex B 3) a minimum of four times.                                                                                                                                                                                                                                                  |
|                                                                                                                                                                                                                      | 2b. Check brush diameter (Table B4). Brush the hole with an appropriate sized wire brush $> d_{b,\text{min}}$ (Table B4) a minimum of four times in a twisting motion.<br>If the bore hole ground is not reached with the brush, a brush extension must be used.                                                                                                                              |
|                                                                                                                                                                                                                     | 2c. Finally blow the hole clean again with a hand pump (Annex B 3) a minimum of four times.                                                                                                                                                                                                                                                                                                   |
| <sup>1)</sup> It is permitted to blow bore holes with diameter between 14 mm and 20 mm and an embedment depth up to $10d_{\text{nom}}$ also in cracked concrete with hand-pump.                                                                                                                        |                                                                                                                                                                                                                                                                                                                                                                                               |
| CAC: Cleaning for all bore hole diameter in uncracked and cracked concrete                                                                                                                                                                                                                             |                                                                                                                                                                                                                                                                                                                                                                                               |
|                                                                                                                                                                                                                     | 2a. Starting from the bottom or back of the bore hole, blow the hole clean with compressed air (min. 6 bar) (Annex B 3) a minimum of four times until return air stream is free of noticeable dust. If the bore hole ground is not reached an extension must be used.                                                                                                                         |
|                                                                                                                                                                                                                     | 2b. Check brush diameter (Table B4). Brush the hole with an appropriate sized wire brush $> d_{b,\text{min}}$ (Table B4) a minimum of four times in a twisting motion.<br>If the bore hole ground is not reached with the brush, a brush extension must be used.                                                                                                                              |
|                                                                                                                                                                                                                     | 2c. Finally blow the hole clean again with compressed air (min. 6 bar) (Annex B 3) a minimum of four times until return air stream is free of noticeable dust. If the bore hole ground is not reached an extension must be used.                                                                                                                                                              |
| <b>After cleaning, the bore hole has to be protected against re-contamination in an appropriate way, until dispensing the mortar in the bore hole. If necessary, the cleaning has to be repeated directly before dispensing the mortar. In-flowing water must not contaminate the bore hole again.</b> |                                                                                                                                                                                                                                                                                                                                                                                               |
| Injection System ESSVE ONE, ESSVE ONE-ICE for concrete                                                                                                                                                                                                                                                 | <b>Annex B 4</b>                                                                                                                                                                                                                                                                                                                                                                              |
| Intended Use<br>Installation instructions                                                                                                                                                                                                                                                              |                                                                                                                                                                                                                                                                                                                                                                                               |

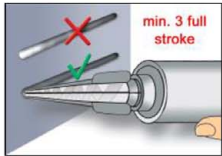
**Installation instructions (continuation)**



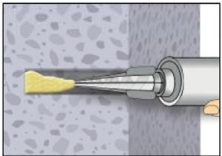
3. Attach the supplied static-mixing nozzle to the cartridge and load the cartridge into the correct dispensing tool. Cut off the foil tube clip before use. For every working interruption longer than the recommended working time (Annex B 6) as well as for new cartridges, a new static-mixer shall be used.



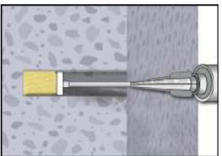
4. Prior to inserting the anchor rod into the filled bore hole, the position of the embedment depth shall be marked on the anchor rods.



5. Prior to dispensing into the anchor hole, squeeze out separately a minimum of three full strokes and discard non-uniformly mixed adhesive components until the mortar shows a consistent grey colour. For foil tube cartridges it must be discarded a minimum of six full strokes.

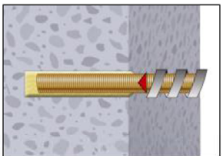


6. Starting from the bottom or back of the cleaned anchor hole, fill the hole up to approximately two-thirds with adhesive. Slowly withdraw the static mixing nozzle as the hole fills to avoid creating air pockets. If the bottom or back of the anchor hole is not reached, an appropriate extension nozzle must be used. Observe the gel-/ working times given in Annex B 6.



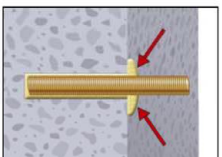
7. Piston plugs and mixer nozzle extensions shall be used according to Table B4 for the following applications:

- Horizontal assembly (horizontal direction) and ground erection (vertical downwards direction): Drill bit- $\varnothing d_0 \geq 18$  mm and embedment depth  $h_{ef} > 250$ mm
- Overhead assembly (vertical upwards direction): Drill bit- $\varnothing d_0 \geq 18$  mm

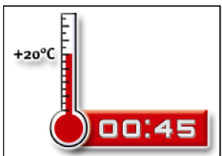


8. Push the threaded rod or reinforcing bar into the anchor hole while turning slightly to ensure positive distribution of the adhesive until the embedment depth is reached.

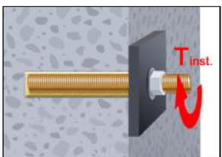
The anchor shall be free of dirt, grease, oil or other foreign material.



9. Be sure that the anchor is fully seated at the bottom of the hole and that excess mortar is visible at the top of the hole. If these requirements are not maintained, the application has to be renewed. For overhead application the anchor rod shall be fixed (e.g. wedges).



10. Allow the adhesive to cure to the specified time prior to applying any load or torque. Do not move or load the anchor until it is fully cured (attend Annex B 6).



11. After full curing, the add-on part can be installed with up to the max. torque (Table B1 or B3) by using a calibrated torque wrench. It can be optional filled the annular gap between anchor and fixture with mortar. Therefor substitute the washer by the filling washer and connect the mixer reduction nozzle to the tip of the mixer. The annular gap is filled with mortar, when mortar oozes out of the washer.

**Injection System ESSVE ONE, ESSVE ONE-ICE for concrete**

**Intended Use**

Installation instructions (continuation)

**Annex B 5**



| <b>Table B5: Maximum working time and minimum curing time<br/>ESSVE ONE</b>                                                  |                                |                                                              |
|------------------------------------------------------------------------------------------------------------------------------|--------------------------------|--------------------------------------------------------------|
| <b>Concrete temperature</b>                                                                                                  | <b>Gelling- / working time</b> | <b>Minimum curing time<br/>in dry concrete <sup>1)</sup></b> |
| -10 °C to -6°C                                                                                                               | 90 min <sup>2)</sup>           | 24 h <sup>2)</sup>                                           |
| -5 °C to -1°C                                                                                                                | 90 min                         | 14 h                                                         |
| 0 °C to +4°C                                                                                                                 | 45 min                         | 7 h                                                          |
| +5 °C to +9°C                                                                                                                | 25 min                         | 2 h                                                          |
| + 10 °C to +19°C                                                                                                             | 15 min                         | 80 min                                                       |
| + 20 °C to +29°C                                                                                                             | 6 min                          | 45 min                                                       |
| + 30 °C to +34°C                                                                                                             | 4 min                          | 25 min                                                       |
| + 35 °C to +39°C                                                                                                             | 2 min                          | 20 min                                                       |
| + 40 °C                                                                                                                      | 1,5 min                        | 15 min                                                       |
| Cartridge temperature                                                                                                        | +5°C to +40°C                  |                                                              |
| <sup>1)</sup> In wet concrete the curing time must be doubled.<br><sup>2)</sup> Cartridge temperature must be at min. +15°C. |                                |                                                              |
| <b>Table B6: Maximum working time and minimum curing time<br/>ESSVE ONE-ICE</b>                                              |                                |                                                              |
| <b>Concrete temperature</b>                                                                                                  | <b>Gelling- / working time</b> | <b>Minimum curing time<br/>in dry concrete <sup>1)</sup></b> |
| -20 °C to -16°C                                                                                                              | 75 min                         | 24 h                                                         |
| -15 °C to -11°C                                                                                                              | 55 min                         | 16 h                                                         |
| -10 °C to -6°C                                                                                                               | 35 min                         | 10 h                                                         |
| -5 °C to -1°C                                                                                                                | 20 min                         | 5 h                                                          |
| 0 °C to +4°C                                                                                                                 | 10 min                         | 2,5 h                                                        |
| +5 °C to +9°C                                                                                                                | 6 min                          | 80 Min                                                       |
| + 10 °C                                                                                                                      | 6 min                          | 60 Min                                                       |
| Cartridge temperature                                                                                                        | -20°C to +10°C                 |                                                              |
| <sup>1)</sup> In wet concrete the curing time must be doubled.                                                               |                                |                                                              |
| <b>Injection System ESSVE ONE, ESSVE ONE-ICE for concrete</b>                                                                |                                | <b>Annex B 6</b>                                             |
| <b>Intended Use</b><br>Curing time                                                                                           |                                |                                                              |

| <b>Table C1: Characteristic values for steel tension resistance and steel shear resistance of threaded rods</b>                                                                                                                                                                                |                                          |                    |           |            |            |            |            |            |                  |            |      |
|------------------------------------------------------------------------------------------------------------------------------------------------------------------------------------------------------------------------------------------------------------------------------------------------|------------------------------------------|--------------------|-----------|------------|------------|------------|------------|------------|------------------|------------|------|
| <b>Size</b>                                                                                                                                                                                                                                                                                    |                                          |                    | <b>M8</b> | <b>M10</b> | <b>M12</b> | <b>M16</b> | <b>M20</b> | <b>M24</b> | <b>M27</b>       | <b>M30</b> |      |
| Cross section area                                                                                                                                                                                                                                                                             | $A_s$                                    | [mm <sup>2</sup> ] | 36,6      | 58         | 84,3       | 157        | 245        | 353        | 459              | 561        |      |
| Characteristic tension resistance, Steel failure <sup>1)</sup>                                                                                                                                                                                                                                 |                                          |                    |           |            |            |            |            |            |                  |            |      |
| Steel, Property class 4.6 and 4.8                                                                                                                                                                                                                                                              | $N_{Rk,s}$                               | [kN]               | 15 (13)   | 23 (21)    | 34         | 63         | 98         | 141        | 184              | 224        |      |
| Steel, Property class 5.6 and 5.8                                                                                                                                                                                                                                                              | $N_{Rk,s}$                               | [kN]               | 18 (17)   | 29 (27)    | 42         | 78         | 122        | 176        | 230              | 280        |      |
| Steel, Property class 8.8                                                                                                                                                                                                                                                                      | $N_{Rk,s}$                               | [kN]               | 29 (27)   | 46 (43)    | 67         | 125        | 196        | 282        | 368              | 449        |      |
| Stainless steel A2, A4 and HCR, class 50                                                                                                                                                                                                                                                       | $N_{Rk,s}$                               | [kN]               | 18        | 29         | 42         | 79         | 123        | 177        | 230              | 281        |      |
| Stainless steel A2, A4 and HCR, class 70                                                                                                                                                                                                                                                       | $N_{Rk,s}$                               | [kN]               | 26        | 41         | 59         | 110        | 171        | 247        | -                | -          |      |
| Stainless steel A4 and HCR, class 80                                                                                                                                                                                                                                                           | $N_{Rk,s}$                               | [kN]               | 29        | 46         | 67         | 126        | 196        | 282        | -                | -          |      |
| Characteristic tension resistance, Partial factor <sup>2)</sup>                                                                                                                                                                                                                                |                                          |                    |           |            |            |            |            |            |                  |            |      |
| Steel, Property class 4.6 and 5.6                                                                                                                                                                                                                                                              | $\gamma_{Ms,N}$                          | [-]                | 2,0       |            |            |            |            |            |                  |            |      |
| Steel, Property class 4.8, 5.8 and 8.8                                                                                                                                                                                                                                                         | $\gamma_{Ms,N}$                          | [-]                | 1,5       |            |            |            |            |            |                  |            |      |
| Stainless steel A2, A4 and HCR, class 50                                                                                                                                                                                                                                                       | $\gamma_{Ms,N}$                          | [-]                | 2,86      |            |            |            |            |            |                  |            |      |
| Stainless steel A2, A4 and HCR, class 70                                                                                                                                                                                                                                                       | $\gamma_{Ms,N}$                          | [-]                | 1,87      |            |            |            |            |            |                  |            |      |
| Stainless steel A4 and HCR, class 80                                                                                                                                                                                                                                                           | $\gamma_{Ms,N}$                          | [-]                | 1,6       |            |            |            |            |            |                  |            |      |
| Characteristic shear resistance, Steel failure <sup>1)</sup>                                                                                                                                                                                                                                   |                                          |                    |           |            |            |            |            |            |                  |            |      |
| Without lever arm                                                                                                                                                                                                                                                                              | Steel, Property class 4.6 and 4.8        | $V^0_{Rk,s}$       | [kN]      | 9 (8)      | 14 (13)    | 20         | 38         | 59         | 85               | 110        | 135  |
|                                                                                                                                                                                                                                                                                                | Steel, Property class 5.6 and 5.8        | $V^0_{Rk,s}$       | [kN]      | 11 (10)    | 17 (16)    | 25         | 47         | 74         | 106              | 138        | 168  |
|                                                                                                                                                                                                                                                                                                | Steel, Property class 8.8                | $V^0_{Rk,s}$       | [kN]      | 15 (13)    | 23 (21)    | 34         | 63         | 98         | 141              | 184        | 224  |
|                                                                                                                                                                                                                                                                                                | Stainless steel A2, A4 and HCR, class 50 | $V^0_{Rk,s}$       | [kN]      | 9          | 15         | 21         | 39         | 61         | 88               | 115        | 140  |
|                                                                                                                                                                                                                                                                                                | Stainless steel A2, A4 and HCR, class 70 | $V^0_{Rk,s}$       | [kN]      | 13         | 20         | 30         | 55         | 86         | 124              | -          | -    |
|                                                                                                                                                                                                                                                                                                | Stainless steel A4 and HCR, class 80     | $V^0_{Rk,s}$       | [kN]      | 15         | 23         | 34         | 63         | 98         | 141              | -          | -    |
| With lever arm                                                                                                                                                                                                                                                                                 | Steel, Property class 4.6 and 4.8        | $M^0_{Rk,s}$       | [Nm]      | 15 (13)    | 30 (27)    | 52         | 133        | 260        | 449              | 666        | 900  |
|                                                                                                                                                                                                                                                                                                | Steel, Property class 5.6 and 5.8        | $M^0_{Rk,s}$       | [Nm]      | 19 (16)    | 37 (33)    | 65         | 166        | 324        | 560              | 833        | 1123 |
|                                                                                                                                                                                                                                                                                                | Steel, Property class 8.8                | $M^0_{Rk,s}$       | [Nm]      | 30 (26)    | 60 (53)    | 105        | 266        | 519        | 896              | 1333       | 1797 |
|                                                                                                                                                                                                                                                                                                | Stainless steel A2, A4 and HCR, class 50 | $M^0_{Rk,s}$       | [Nm]      | 19         | 37         | 66         | 167        | 325        | 561              | 832        | 1125 |
|                                                                                                                                                                                                                                                                                                | Stainless steel A2, A4 and HCR, class 70 | $M^0_{Rk,s}$       | [Nm]      | 26         | 52         | 92         | 232        | 454        | 784              | -          | -    |
|                                                                                                                                                                                                                                                                                                | Stainless steel A4 and HCR, class 80     | $M^0_{Rk,s}$       | [Nm]      | 30         | 59         | 105        | 266        | 519        | 896              | -          | -    |
| Characteristic shear resistance, Partial factor <sup>2)</sup>                                                                                                                                                                                                                                  |                                          |                    |           |            |            |            |            |            |                  |            |      |
| Steel, Property class 4.6 and 5.6                                                                                                                                                                                                                                                              | $\gamma_{Ms,V}$                          | [-]                | 1,67      |            |            |            |            |            |                  |            |      |
| Steel, Property class 4.8, 5.8 and 8.8                                                                                                                                                                                                                                                         | $\gamma_{Ms,V}$                          | [-]                | 1,25      |            |            |            |            |            |                  |            |      |
| Stainless steel A2, A4 and HCR, class 50                                                                                                                                                                                                                                                       | $\gamma_{Ms,V}$                          | [-]                | 2,38      |            |            |            |            |            |                  |            |      |
| Stainless steel A2, A4 and HCR, class 70                                                                                                                                                                                                                                                       | $\gamma_{Ms,V}$                          | [-]                | 1,56      |            |            |            |            |            |                  |            |      |
| Stainless steel A4 and HCR, class 80                                                                                                                                                                                                                                                           | $\gamma_{Ms,V}$                          | [-]                | 1,33      |            |            |            |            |            |                  |            |      |
| <sup>1)</sup> Values are only valid for the given stress area $A_s$ . Values in brackets are valid for undersized threaded rods with smaller stress area $A_s$ for hot-dip galvanised threaded rods according to EN ISO 10684:2004+AC:2009.<br><sup>2)</sup> in absence of national regulation |                                          |                    |           |            |            |            |            |            |                  |            |      |
| <b>Injection System ESSVE ONE, ESSVE ONE-ICE for concrete</b>                                                                                                                                                                                                                                  |                                          |                    |           |            |            |            |            |            | <b>Annex C 1</b> |            |      |
| <b>Performances</b><br>Characteristic values for steel tension resistance and steel shear resistance of threaded rods                                                                                                                                                                          |                                          |                    |           |            |            |            |            |            |                  |            |      |

**Table C2: Characteristic values for Concrete cone failure and Splitting with all kind of action**

| Anchor size                                                                                                  |                        | All Anchor types and sizes |      |                                                        |
|--------------------------------------------------------------------------------------------------------------|------------------------|----------------------------|------|--------------------------------------------------------|
| <b>Concrete cone failure</b>                                                                                 |                        |                            |      |                                                        |
| Non-cracked concrete                                                                                         |                        | $k_{ucr,N}$                | [-]  | 11,0                                                   |
| Cracked concrete                                                                                             |                        | $k_{cr,N}$                 | [-]  | 7,7                                                    |
| Edge distance                                                                                                |                        | $c_{cr,N}$                 | [mm] | $1,5 h_{ef}$                                           |
| Axial distance                                                                                               |                        | $s_{cr,N}$                 | [mm] | $2 c_{cr,N}$                                           |
| <b>Splitting</b>                                                                                             |                        |                            |      |                                                        |
| Edge distance                                                                                                | $h/h_{ef} \geq 2,0$    | $c_{cr,sp}$                | [mm] | $1,0 h_{ef}$                                           |
|                                                                                                              | $2,0 > h/h_{ef} > 1,3$ |                            |      | $2 \cdot h_{ef} \left( 2,5 - \frac{h}{h_{ef}} \right)$ |
|                                                                                                              | $h/h_{ef} \leq 1,3$    |                            |      | $2,4 h_{ef}$                                           |
| Axial distance                                                                                               |                        | $s_{cr,sp}$                | [mm] | $2 c_{cr,sp}$                                          |
|                                                                                                              |                        |                            |      |                                                        |
| <b>Injection System ESSVE ONE, ESSVE ONE-ICE for concrete</b>                                                |                        |                            |      | <b>Annex C 2</b>                                       |
| <b>Performances</b><br>Characteristic values for Concrete cone failure and Splitting with all kind of action |                        |                            |      |                                                        |

| <b>Table C3: Characteristic values of tension loads under static and quasi-static action</b>       |                 |                                         |                 |                                      |            |            |            |            |                               |                  |            |     |  |
|----------------------------------------------------------------------------------------------------|-----------------|-----------------------------------------|-----------------|--------------------------------------|------------|------------|------------|------------|-------------------------------|------------------|------------|-----|--|
| <b>Anchor size threaded rod</b>                                                                    |                 |                                         |                 | <b>M8</b>                            | <b>M10</b> | <b>M12</b> | <b>M16</b> | <b>M20</b> | <b>M24</b>                    | <b>M27</b>       | <b>M30</b> |     |  |
| Steel failure                                                                                      |                 |                                         |                 |                                      |            |            |            |            |                               |                  |            |     |  |
| Characteristic tension resistance                                                                  |                 | $N_{Rk,s}$                              | [kN]            | $A_s \cdot f_{uk}$ (or see Table C1) |            |            |            |            |                               |                  |            |     |  |
| Partial factor                                                                                     |                 | $\gamma_{Ms,N}$                         | [-]             | see Table C1                         |            |            |            |            |                               |                  |            |     |  |
| <b>Combined pull-out and concrete failure</b>                                                      |                 |                                         |                 |                                      |            |            |            |            |                               |                  |            |     |  |
| Characteristic bond resistance in non-cracked concrete C20/25                                      |                 |                                         |                 |                                      |            |            |            |            |                               |                  |            |     |  |
| Temperature range                                                                                  | I: 40°C/24°C    | Dry, wet concrete                       | $\tau_{Rk,ucr}$ | [N/mm <sup>2</sup> ]                 | 10         | 12         | 12         | 12         | 12                            | 11               | 10         | 9   |  |
|                                                                                                    | II: 80°C/50°C   |                                         |                 |                                      | 7,5        | 9          | 9          | 9          | 9                             | 8,5              | 7,5        | 6,5 |  |
|                                                                                                    | III: 120°C/72°C |                                         |                 |                                      | 5,5        | 6,5        | 6,5        | 6,5        | 6,5                           | 6,5              | 5,5        | 5,0 |  |
|                                                                                                    | I: 40°C/24°C    | flooded bore hole                       |                 |                                      | 7,5        | 8,5        | 8,5        | 8,5        | No Performance Assessed (NPA) |                  |            |     |  |
|                                                                                                    | II: 80°C/50°C   |                                         |                 |                                      | 5,5        | 6,5        | 6,5        | 6,5        |                               |                  |            |     |  |
|                                                                                                    | III: 120°C/72°C |                                         |                 |                                      | 4,0        | 5,0        | 5,0        | 5,0        |                               |                  |            |     |  |
| Characteristic bond resistance in cracked concrete C20/25                                          |                 |                                         |                 |                                      |            |            |            |            |                               |                  |            |     |  |
| Temperature range                                                                                  | I: 40°C/24°C    | Dry, wet concrete                       | $\tau_{Rk,cr}$  | [N/mm <sup>2</sup> ]                 | 4,0        | 5,0        | 5,5        | 5,5        | 5,5                           | 5,5              | 6,5        | 6,5 |  |
|                                                                                                    | II: 80°C/50°C   |                                         |                 |                                      | 2,5        | 3,5        | 4,0        | 4,0        | 4,0                           | 4,0              | 4,5        | 4,5 |  |
|                                                                                                    | III: 120°C/72°C |                                         |                 |                                      | 2,0        | 2,5        | 3,0        | 3,0        | 3,0                           | 3,0              | 3,5        | 3,5 |  |
|                                                                                                    | I: 40°C/24°C    | flooded bore hole                       |                 |                                      | 4,0        | 4,0        | 5,5        | 5,5        | No Performance Assessed (NPA) |                  |            |     |  |
|                                                                                                    | II: 80°C/50°C   |                                         |                 |                                      | 2,5        | 3,0        | 4,0        | 4,0        |                               |                  |            |     |  |
|                                                                                                    | III: 120°C/72°C |                                         |                 |                                      | 2,0        | 2,5        | 3,0        | 3,0        |                               |                  |            |     |  |
| Reduktion factor $\psi_{sus}^0$ in cracked and non-cracked concrete C20/25                         |                 |                                         |                 |                                      |            |            |            |            |                               |                  |            |     |  |
| Temperature range                                                                                  | I: 40°C/24°C    | Dry, wet concrete and flooded bore hole | $\psi_{sus}^0$  | [-]                                  | 0,73       |            |            |            |                               |                  |            |     |  |
|                                                                                                    | II: 80°C/50°C   |                                         |                 |                                      | 0,65       |            |            |            |                               |                  |            |     |  |
|                                                                                                    | III: 120°C/72°C |                                         |                 |                                      | 0,57       |            |            |            |                               |                  |            |     |  |
| Increasing factors for concrete $\psi_c$                                                           |                 |                                         | C25/30          |                                      | 1,02       |            |            |            |                               |                  |            |     |  |
|                                                                                                    |                 |                                         | C30/37          |                                      | 1,04       |            |            |            |                               |                  |            |     |  |
|                                                                                                    |                 |                                         | C35/45          |                                      | 1,07       |            |            |            |                               |                  |            |     |  |
|                                                                                                    |                 |                                         | C40/50          |                                      | 1,08       |            |            |            |                               |                  |            |     |  |
|                                                                                                    |                 |                                         | C45/55          |                                      | 1,09       |            |            |            |                               |                  |            |     |  |
|                                                                                                    |                 |                                         | C50/60          |                                      | 1,10       |            |            |            |                               |                  |            |     |  |
| <b>Concrete cone failure</b>                                                                       |                 |                                         |                 |                                      |            |            |            |            |                               |                  |            |     |  |
| Relevant parameter                                                                                 |                 |                                         |                 | see Table C2                         |            |            |            |            |                               |                  |            |     |  |
| <b>Splitting</b>                                                                                   |                 |                                         |                 |                                      |            |            |            |            |                               |                  |            |     |  |
| Relevant parameter                                                                                 |                 |                                         |                 | see Table C2                         |            |            |            |            |                               |                  |            |     |  |
| <b>Installation factor</b>                                                                         |                 |                                         |                 |                                      |            |            |            |            |                               |                  |            |     |  |
| for dry and wet concrete                                                                           |                 | $\gamma_{inst}$                         | [-]             | 1,0                                  | 1,2        |            |            |            |                               |                  |            |     |  |
| for flooded bore hole                                                                              |                 |                                         |                 | 1,4                                  |            |            |            | NPA        |                               |                  |            |     |  |
| <b>Injection System ESSVE ONE, ESSVE ONE-ICE for concrete</b>                                      |                 |                                         |                 |                                      |            |            |            |            |                               | <b>Annex C 3</b> |            |     |  |
| <b>Performances</b><br>Characteristic values of tension loads under static and quasi-static action |                 |                                         |                 |                                      |            |            |            |            |                               |                  |            |     |  |

| Table C4: Characteristic values of shear loads under static and quasi-static action                         |                 |                    |                                                   |     |     |     |     |     |                              |      |  |
|-------------------------------------------------------------------------------------------------------------|-----------------|--------------------|---------------------------------------------------|-----|-----|-----|-----|-----|------------------------------|------|--|
| Anchor size threaded rod                                                                                    |                 |                    | M8                                                | M10 | M12 | M16 | M20 | M24 | M27                          | M30  |  |
| <b>Steel failure without lever arm</b>                                                                      |                 |                    |                                                   |     |     |     |     |     |                              |      |  |
| Characteristic shear resistance<br>Steel, strength class 4.6, 4.8, 5.6 and 5.8                              | $V_{Rk,s}^0$    | [kN]               | $0,6 \cdot A_s \cdot f_{uk}$ (or see Table C1)    |     |     |     |     |     |                              |      |  |
| Characteristic shear resistance<br>Steel, strength class 8.8<br>Stainless Steel A2, A4 and HCR, all classes | $V_{Rk,s}^0$    | [kN]               | $0,5 \cdot A_s \cdot f_{uk}$ (or see Table C1)    |     |     |     |     |     |                              |      |  |
| Partial factor                                                                                              | $\gamma_{Ms,V}$ | [-]                | see Table C1                                      |     |     |     |     |     |                              |      |  |
| Ductility factor                                                                                            | $k_7$           | [-]                | 1,0                                               |     |     |     |     |     |                              |      |  |
| <b>Steel failure with lever arm</b>                                                                         |                 |                    |                                                   |     |     |     |     |     |                              |      |  |
| Characteristic bending moment                                                                               | $M_{Rk,s}^0$    | [Nm]               | $1,2 \cdot W_{el} \cdot f_{uk}$ (or see Table C1) |     |     |     |     |     |                              |      |  |
| Elastic section modulus                                                                                     | $W_{el}$        | [mm <sup>3</sup> ] | 31                                                | 62  | 109 | 277 | 541 | 935 | 1387                         | 1874 |  |
| Partial factor                                                                                              | $\gamma_{Ms,V}$ | [-]                | see Table C1                                      |     |     |     |     |     |                              |      |  |
| <b>Concrete pry-out failure</b>                                                                             |                 |                    |                                                   |     |     |     |     |     |                              |      |  |
| Factor                                                                                                      | $k_8$           | [-]                | 2,0                                               |     |     |     |     |     |                              |      |  |
| Installation factor                                                                                         | $\gamma_{inst}$ | [-]                | 1,0                                               |     |     |     |     |     |                              |      |  |
| <b>Concrete edge failure</b>                                                                                |                 |                    |                                                   |     |     |     |     |     |                              |      |  |
| Effective length of fastener                                                                                | $l_f$           | [mm]               | $\min(h_{ef}; 12 \cdot d_{nom})$                  |     |     |     |     |     | $\min(h_{ef}; 300\text{mm})$ |      |  |
| Outside diameter of fastener                                                                                | $d_{nom}$       | [mm]               | 8                                                 | 10  | 12  | 16  | 20  | 24  | 27                           | 30   |  |
| Installation factor                                                                                         | $\gamma_{inst}$ | [-]                | 1,0                                               |     |     |     |     |     |                              |      |  |
|                                                                                                             |                 |                    |                                                   |     |     |     |     |     |                              |      |  |
| <b>Injection System ESSVE ONE, ESSVE ONE-ICE for concrete</b>                                               |                 |                    |                                                   |     |     |     |     |     | <b>Annex C 4</b>             |      |  |
| <b>Performances</b><br>Characteristic values of shear loads under static and quasi-static action            |                 |                    |                                                   |     |     |     |     |     |                              |      |  |

| <b>Table C5: Characteristic values of tension loads under static and quasi-static action</b>                                                                                                                                                                                                                                |                     |                                         |                                      |                 |              |               |               |                               |               |     |  |
|-----------------------------------------------------------------------------------------------------------------------------------------------------------------------------------------------------------------------------------------------------------------------------------------------------------------------------|---------------------|-----------------------------------------|--------------------------------------|-----------------|--------------|---------------|---------------|-------------------------------|---------------|-----|--|
| <b>Anchor size internal threaded anchor rods</b>                                                                                                                                                                                                                                                                            |                     |                                         |                                      | <b>IG-M6</b>    | <b>IG-M8</b> | <b>IG-M10</b> | <b>IG-M12</b> | <b>IG-M16</b>                 | <b>IG-M20</b> |     |  |
| <b>Steel failure<sup>1)</sup></b>                                                                                                                                                                                                                                                                                           |                     |                                         |                                      |                 |              |               |               |                               |               |     |  |
| Characteristic tension resistance, Steel, strength class                                                                                                                                                                                                                                                                    | 5.8<br>8.8          | $N_{Rk,s}$                              | [kN]                                 | 10<br>16        | 17<br>27     | 29<br>46      | 42<br>67      | 76<br>121                     | 123<br>196    |     |  |
| Partial factor, strength class 5.8 and 8.8                                                                                                                                                                                                                                                                                  | $\gamma_{Ms,N}$ [-] |                                         |                                      | 1,5             |              |               |               |                               |               |     |  |
| Characteristic tension resistance, Stainless Steel A4 and HCR, Strength class 70 <sup>2)</sup>                                                                                                                                                                                                                              |                     | $N_{Rk,s}$                              | [kN]                                 | 14              | 26           | 41            | 59            | 110                           | 124           |     |  |
| Partial factor                                                                                                                                                                                                                                                                                                              | $\gamma_{Ms,N}$ [-] |                                         |                                      | 1,87            |              |               |               |                               | 2,86          |     |  |
| <b>Combined pull-out and concrete cone failure</b>                                                                                                                                                                                                                                                                          |                     |                                         |                                      |                 |              |               |               |                               |               |     |  |
| Characteristic bond resistance in non-cracked concrete C20/25                                                                                                                                                                                                                                                               |                     |                                         |                                      |                 |              |               |               |                               |               |     |  |
| Temperature range                                                                                                                                                                                                                                                                                                           | I: 40°C/24°C        | Dry, wet concrete                       | $\tau_{Rk,ucr}$ [N/mm <sup>2</sup> ] |                 | 12           | 12            | 12            | 12                            | 11            | 9   |  |
|                                                                                                                                                                                                                                                                                                                             | II: 80°C/50°C       |                                         |                                      |                 | 9            | 9             | 9             | 9                             | 8,5           | 6,5 |  |
|                                                                                                                                                                                                                                                                                                                             | III: 120°C/72°C     |                                         |                                      |                 | 6,5          | 6,5           | 6,5           | 6,5                           | 6,5           | 5,0 |  |
|                                                                                                                                                                                                                                                                                                                             | I: 40°C/24°C        | flooded bore hole                       |                                      |                 | 8,5          | 8,5           | 8,5           | No Performance Assessed (NPA) |               |     |  |
|                                                                                                                                                                                                                                                                                                                             | II: 80°C/50°C       |                                         |                                      |                 | 6,5          | 6,5           | 6,5           |                               |               |     |  |
|                                                                                                                                                                                                                                                                                                                             | III: 120°C/72°C     |                                         |                                      |                 | 5,0          | 5,0           | 5,0           |                               |               |     |  |
| Characteristic bond resistance in cracked concrete C20/25                                                                                                                                                                                                                                                                   |                     |                                         |                                      |                 |              |               |               |                               |               |     |  |
| Temperature range                                                                                                                                                                                                                                                                                                           | I: 40°C/24°C        | Dry, wet concrete                       | $\tau_{Rk,cr}$ [N/mm <sup>2</sup> ]  |                 | 5,0          | 5,5           | 5,5           | 5,5                           | 5,5           | 6,5 |  |
|                                                                                                                                                                                                                                                                                                                             | II: 80°C/50°C       |                                         |                                      |                 | 3,5          | 4,0           | 4,0           | 4,0                           | 4,0           | 4,5 |  |
|                                                                                                                                                                                                                                                                                                                             | III: 120°C/72°C     |                                         |                                      |                 | 2,5          | 3,0           | 3,0           | 3,0                           | 3,0           | 3,5 |  |
|                                                                                                                                                                                                                                                                                                                             | I: 40°C/24°C        | flooded bore hole                       |                                      |                 | 4,0          | 5,5           | 5,5           | No Performance Assessed (NPA) |               |     |  |
|                                                                                                                                                                                                                                                                                                                             | II: 80°C/50°C       |                                         |                                      |                 | 3,0          | 4,0           | 4,0           |                               |               |     |  |
|                                                                                                                                                                                                                                                                                                                             | III: 120°C/72°C     |                                         |                                      |                 | 2,5          | 3,0           | 3,0           |                               |               |     |  |
| Reduktion factor $\psi_{SUS}^0$ in cracked and non-cracked concrete C20/25                                                                                                                                                                                                                                                  |                     |                                         |                                      |                 |              |               |               |                               |               |     |  |
| Temperature range                                                                                                                                                                                                                                                                                                           | I: 40°C/24°C        | Dry, wet concrete and flooded bore hole | $\psi_{SUS}^0$ [-]                   |                 | 0,73         |               |               |                               |               |     |  |
|                                                                                                                                                                                                                                                                                                                             | II: 80°C/50°C       |                                         |                                      |                 | 0,65         |               |               |                               |               |     |  |
|                                                                                                                                                                                                                                                                                                                             | III: 120°C/72°C     |                                         |                                      |                 | 0,57         |               |               |                               |               |     |  |
| Increasing factors for concrete $\psi_c$                                                                                                                                                                                                                                                                                    | C25/30              |                                         |                                      | 1,02            |              |               |               |                               |               |     |  |
|                                                                                                                                                                                                                                                                                                                             | C30/37              |                                         |                                      | 1,04            |              |               |               |                               |               |     |  |
|                                                                                                                                                                                                                                                                                                                             | C35/45              |                                         |                                      | 1,07            |              |               |               |                               |               |     |  |
|                                                                                                                                                                                                                                                                                                                             | C40/50              |                                         |                                      | 1,08            |              |               |               |                               |               |     |  |
|                                                                                                                                                                                                                                                                                                                             | C45/55              |                                         |                                      | 1,09            |              |               |               |                               |               |     |  |
|                                                                                                                                                                                                                                                                                                                             | C50/60              |                                         |                                      | 1,10            |              |               |               |                               |               |     |  |
| <b>Concrete cone failure</b>                                                                                                                                                                                                                                                                                                |                     |                                         |                                      |                 |              |               |               |                               |               |     |  |
| Relevant parameter                                                                                                                                                                                                                                                                                                          |                     |                                         |                                      | see Table C2    |              |               |               |                               |               |     |  |
| <b>Splitting failure</b>                                                                                                                                                                                                                                                                                                    |                     |                                         |                                      |                 |              |               |               |                               |               |     |  |
| Relevant parameter                                                                                                                                                                                                                                                                                                          |                     |                                         |                                      | see Table C2    |              |               |               |                               |               |     |  |
| <b>Installation factor</b>                                                                                                                                                                                                                                                                                                  |                     |                                         |                                      |                 |              |               |               |                               |               |     |  |
| for dry and wet concrete                                                                                                                                                                                                                                                                                                    |                     |                                         |                                      | $\gamma_{inst}$ | [-]          | 1,2           |               |                               |               |     |  |
| for flooded bore hole                                                                                                                                                                                                                                                                                                       |                     |                                         |                                      |                 |              | 1,4           |               | NPA                           |               |     |  |
| <sup>1)</sup> Fastenings (incl. nut and washer) must comply with the appropriate material and property class of the internal threaded rod. The characteristic tension resistance for steel failure is valid for the internal threaded rod and the fastening element.<br><sup>2)</sup> For IG-M20 strength class 50 is valid |                     |                                         |                                      |                 |              |               |               |                               |               |     |  |
| <b>Injection System ESSVE ONE, ESSVE ONE-ICE for concrete</b>                                                                                                                                                                                                                                                               |                     |                                         |                                      |                 |              |               |               | <b>Annex C 5</b>              |               |     |  |
| <b>Performances</b><br>Characteristic values of tension loads under static and quasi-static action                                                                                                                                                                                                                          |                     |                                         |                                      |                 |              |               |               |                               |               |     |  |

| Table C6: Characteristic values of shear loads under static and quasi-static action                                                                                                                                                                                                                                         |                 |                 |                                  |       |       |        |        |                  |                              |
|-----------------------------------------------------------------------------------------------------------------------------------------------------------------------------------------------------------------------------------------------------------------------------------------------------------------------------|-----------------|-----------------|----------------------------------|-------|-------|--------|--------|------------------|------------------------------|
| Anchor size for internal threaded anchor rods                                                                                                                                                                                                                                                                               |                 |                 |                                  | IG-M6 | IG-M8 | IG-M10 | IG-M12 | IG-M16           | IG-M20                       |
| <b>Steel failure without lever arm<sup>1)</sup></b>                                                                                                                                                                                                                                                                         |                 |                 |                                  |       |       |        |        |                  |                              |
| Characteristic shear resistance,<br>Steel, strength class                                                                                                                                                                                                                                                                   | 5.8             | $V_{Rk,s}^0$    | [kN]                             | 5     | 9     | 15     | 21     | 38               | 61                           |
|                                                                                                                                                                                                                                                                                                                             | 8.8             | $V_{Rk,s}^0$    | [kN]                             | 8     | 14    | 23     | 34     | 60               | 98                           |
| Partial factor, strength class 5.8 and 8.8                                                                                                                                                                                                                                                                                  | $\gamma_{Ms,V}$ | [-]             | 1,25                             |       |       |        |        |                  |                              |
| Characteristic shear resistance,<br>Stainless Steel A4 and HCR,<br>Strength class 70 <sup>2)</sup>                                                                                                                                                                                                                          |                 | $V_{Rk,s}^0$    | [kN]                             | 7     | 13    | 20     | 30     | 55               | 40                           |
|                                                                                                                                                                                                                                                                                                                             | Partial factor  | $\gamma_{Ms,V}$ | [-]                              | 1,56  |       |        |        |                  | 2,38                         |
| Ductility factor                                                                                                                                                                                                                                                                                                            | $k_7$           | [-]             | 1,0                              |       |       |        |        |                  |                              |
| <b>Steel failure with lever arm<sup>1)</sup></b>                                                                                                                                                                                                                                                                            |                 |                 |                                  |       |       |        |        |                  |                              |
| Characteristic bending moment,<br>Steel, strength class                                                                                                                                                                                                                                                                     | 5.8             | $M_{Rk,s}^0$    | [Nm]                             | 8     | 19    | 37     | 66     | 167              | 325                          |
|                                                                                                                                                                                                                                                                                                                             | 8.8             | $M_{Rk,s}^0$    | [Nm]                             | 12    | 30    | 60     | 105    | 267              | 519                          |
| Partial factor, strength class 5.8 and 8.8                                                                                                                                                                                                                                                                                  | $\gamma_{Ms,V}$ | [-]             | 1,25                             |       |       |        |        |                  |                              |
| Characteristic bending moment,<br>Stainless Steel A4 and HCR,<br>Strength class 70 <sup>2)</sup>                                                                                                                                                                                                                            |                 | $M_{Rk,s}^0$    | [Nm]                             | 11    | 26    | 52     | 92     | 233              | 456                          |
|                                                                                                                                                                                                                                                                                                                             | Partial factor  | $\gamma_{Ms,V}$ | [-]                              | 1,56  |       |        |        |                  | 2,38                         |
| <b>Concrete pry-out failure</b>                                                                                                                                                                                                                                                                                             |                 |                 |                                  |       |       |        |        |                  |                              |
| Factor                                                                                                                                                                                                                                                                                                                      | $k_8$           | [-]             | 2,0                              |       |       |        |        |                  |                              |
| Installation factor                                                                                                                                                                                                                                                                                                         | $\gamma_{inst}$ | [-]             | 1,0                              |       |       |        |        |                  |                              |
| <b>Concrete edge failure</b>                                                                                                                                                                                                                                                                                                |                 |                 |                                  |       |       |        |        |                  |                              |
| Effective length of fastener                                                                                                                                                                                                                                                                                                | $l_f$           | [mm]            | $\min(h_{ef}; 12 \cdot d_{nom})$ |       |       |        |        |                  | $\min(h_{ef}; 300\text{mm})$ |
| Outside diameter of fastener                                                                                                                                                                                                                                                                                                | $d_{nom}$       | [mm]            | 10                               | 12    | 16    | 20     | 24     | 30               |                              |
| Installation factor                                                                                                                                                                                                                                                                                                         | $\gamma_{inst}$ | [-]             | 1,0                              |       |       |        |        |                  |                              |
| <sup>1)</sup> Fastenings (incl. nut and washer) must comply with the appropriate material and property class of the internal threaded rod. The characteristic tension resistance for steel failure is valid for the internal threaded rod and the fastening element.<br><sup>2)</sup> For IG-M20 strength class 50 is valid |                 |                 |                                  |       |       |        |        |                  |                              |
| <b>Injection System ESSVE ONE, ESSVE ONE-ICE for concrete</b>                                                                                                                                                                                                                                                               |                 |                 |                                  |       |       |        |        | <b>Annex C 6</b> |                              |
| <b>Performances</b><br>Characteristic values of shear loads under static and quasi-static action                                                                                                                                                                                                                            |                 |                 |                                  |       |       |        |        |                  |                              |

| <b>Table C7: Characteristic values of tension loads under static and quasi-static action</b>                                         |                 |                                         |                         |                      |      |      |      |      |      |                               |      |     |     |  |
|--------------------------------------------------------------------------------------------------------------------------------------|-----------------|-----------------------------------------|-------------------------|----------------------|------|------|------|------|------|-------------------------------|------|-----|-----|--|
| <b>Anchor size reinforcing bar</b>                                                                                                   |                 |                                         | Ø 8                     | Ø 10                 | Ø 12 | Ø 14 | Ø 16 | Ø 20 | Ø 25 | Ø 28                          | Ø 32 |     |     |  |
| <b>Steel failure</b>                                                                                                                 |                 |                                         |                         |                      |      |      |      |      |      |                               |      |     |     |  |
| Characteristic tension resistance                                                                                                    | $N_{Rk,s}$      | [kN]                                    | $A_s \cdot f_{uk}^{1)}$ |                      |      |      |      |      |      |                               |      |     |     |  |
| Cross section area                                                                                                                   | $A_s$           | [mm <sup>2</sup> ]                      | 50                      | 79                   | 113  | 154  | 201  | 314  | 491  | 616                           | 804  |     |     |  |
| Partial factor                                                                                                                       | $\gamma_{Ms,N}$ | [-]                                     | 1,4 <sup>2)</sup>       |                      |      |      |      |      |      |                               |      |     |     |  |
| <b>Combined pull-out and concrete failure</b>                                                                                        |                 |                                         |                         |                      |      |      |      |      |      |                               |      |     |     |  |
| Characteristic bond resistance in non-cracked concrete C20/25                                                                        |                 |                                         |                         |                      |      |      |      |      |      |                               |      |     |     |  |
| Temperature range                                                                                                                    | I: 40°C/24°C    | Dry, wet concrete                       | $\tau_{Rk,ucr}$         | [N/mm <sup>2</sup> ] | 10   | 12   | 12   | 12   | 12   | 12                            | 11   | 10  | 8,5 |  |
|                                                                                                                                      | II: 80°C/50°C   |                                         |                         |                      | 7,5  | 9    | 9    | 9    | 9    | 9                             | 8,0  | 7,0 | 6,0 |  |
|                                                                                                                                      | III: 120°C/72°C |                                         |                         |                      | 5,5  | 6,5  | 6,5  | 6,5  | 6,5  | 6,5                           | 6,0  | 5,0 | 4,5 |  |
|                                                                                                                                      | I: 40°C/24°C    | flooded bore hole                       |                         |                      | 7,5  | 8,5  | 8,5  | 8,5  | 8,5  | No Performance Assessed (NPA) |      |     |     |  |
|                                                                                                                                      | II: 80°C/50°C   |                                         |                         |                      | 5,5  | 6,5  | 6,5  | 6,5  | 6,5  |                               |      |     |     |  |
|                                                                                                                                      | III: 120°C/72°C |                                         |                         |                      | 4,0  | 5,0  | 5,0  | 5,0  | 5,0  |                               |      |     |     |  |
| Characteristic bond resistance in cracked concrete C20/25                                                                            |                 |                                         |                         |                      |      |      |      |      |      |                               |      |     |     |  |
| Temperature range                                                                                                                    | I: 40°C/24°C    | Dry, wet concrete                       | $\tau_{Rk,cr}$          | [N/mm <sup>2</sup> ] | 4,0  | 5,0  | 5,5  | 5,5  | 5,5  | 5,5                           | 5,5  | 6,5 | 6,5 |  |
|                                                                                                                                      | II: 80°C/50°C   |                                         |                         |                      | 2,5  | 3,5  | 4,0  | 4,0  | 4,0  | 4,0                           | 4,0  | 4,5 | 4,5 |  |
|                                                                                                                                      | III: 120°C/72°C |                                         |                         |                      | 2,0  | 2,5  | 3,0  | 3,0  | 3,0  | 3,0                           | 3,0  | 3,5 | 3,5 |  |
|                                                                                                                                      | I: 40°C/24°C    | flooded bore hole                       |                         |                      | 4,0  | 4,0  | 5,5  | 5,5  | 5,5  | No Performance Assessed (NPA) |      |     |     |  |
|                                                                                                                                      | II: 80°C/50°C   |                                         |                         |                      | 2,5  | 3,0  | 4,0  | 4,0  | 4,0  |                               |      |     |     |  |
|                                                                                                                                      | III: 120°C/72°C |                                         |                         |                      | 2,0  | 2,5  | 3,0  | 3,0  | 3,0  |                               |      |     |     |  |
| Reduktion factor $\psi_{sus}^0$ in cracked and non-cracked concrete C20/25                                                           |                 |                                         |                         |                      |      |      |      |      |      |                               |      |     |     |  |
| Temperature range                                                                                                                    | I: 40°C/24°C    | Dry, wet concrete and flooded bore hole | $\psi_{sus}^0$          | [-]                  | 0,73 |      |      |      |      |                               |      |     |     |  |
|                                                                                                                                      | II: 80°C/50°C   |                                         |                         |                      | 0,65 |      |      |      |      |                               |      |     |     |  |
|                                                                                                                                      | III: 120°C/72°C |                                         |                         |                      | 0,57 |      |      |      |      |                               |      |     |     |  |
| Increasing factors for concrete $\psi_c$                                                                                             | C25/30          |                                         |                         | 1,02                 |      |      |      |      |      |                               |      |     |     |  |
|                                                                                                                                      | C30/37          |                                         |                         | 1,04                 |      |      |      |      |      |                               |      |     |     |  |
|                                                                                                                                      | C35/45          |                                         |                         | 1,07                 |      |      |      |      |      |                               |      |     |     |  |
|                                                                                                                                      | C40/50          |                                         |                         | 1,08                 |      |      |      |      |      |                               |      |     |     |  |
|                                                                                                                                      | C45/55          |                                         |                         | 1,09                 |      |      |      |      |      |                               |      |     |     |  |
|                                                                                                                                      | C50/60          |                                         |                         | 1,10                 |      |      |      |      |      |                               |      |     |     |  |
| <b>Concrete cone failure</b>                                                                                                         |                 |                                         |                         |                      |      |      |      |      |      |                               |      |     |     |  |
| Relevant parameter                                                                                                                   |                 |                                         | see Table C2            |                      |      |      |      |      |      |                               |      |     |     |  |
| <b>Splitting</b>                                                                                                                     |                 |                                         |                         |                      |      |      |      |      |      |                               |      |     |     |  |
| Relevant parameter                                                                                                                   |                 |                                         | see Table C2            |                      |      |      |      |      |      |                               |      |     |     |  |
| <b>Installation factor</b>                                                                                                           |                 |                                         |                         |                      |      |      |      |      |      |                               |      |     |     |  |
| for dry and wet concrete                                                                                                             |                 | $\gamma_{inst}$                         | [-]                     | 1,2                  | 1,2  |      |      |      |      |                               |      |     |     |  |
| for flooded bore hole                                                                                                                |                 |                                         |                         | 1,4                  |      |      |      |      | NPA  |                               |      |     |     |  |
| <sup>1)</sup> $f_{uk}$ shall be taken from the specifications of reinforcing bars<br><sup>2)</sup> in absence of national regulation |                 |                                         |                         |                      |      |      |      |      |      |                               |      |     |     |  |
| <b>Injection System ESSVE ONE, ESSVE ONE-ICE for concrete</b>                                                                        |                 |                                         |                         |                      |      |      |      |      |      | <b>Annex C 7</b>              |      |     |     |  |
| <b>Performances</b><br>Characteristic values of tension loads under static and quasi-static action                                   |                 |                                         |                         |                      |      |      |      |      |      |                               |      |     |     |  |



| <b>Table C8: Characteristic values of shear loads under static and quasi-static action</b>                                           |                 |                    |                                      |      |      |      |      |      |                              |      |      |
|--------------------------------------------------------------------------------------------------------------------------------------|-----------------|--------------------|--------------------------------------|------|------|------|------|------|------------------------------|------|------|
| <b>Anchor size reinforcing bar</b>                                                                                                   |                 |                    | Ø 8                                  | Ø 10 | Ø 12 | Ø 14 | Ø 16 | Ø 20 | Ø 25                         | Ø 28 | Ø 32 |
| <b>Steel failure without lever arm</b>                                                                                               |                 |                    |                                      |      |      |      |      |      |                              |      |      |
| Characteristic shear resistance                                                                                                      | $V_{Rk,s}^0$    | [kN]               | $0,50 \cdot A_s \cdot f_{uk}^{1)}$   |      |      |      |      |      |                              |      |      |
| Cross section area                                                                                                                   | $A_s$           | [mm <sup>2</sup> ] | 50                                   | 79   | 113  | 154  | 201  | 314  | 491                          | 616  | 804  |
| Partial factor                                                                                                                       | $\gamma_{Ms,V}$ | [-]                | $1,5^{2)}$                           |      |      |      |      |      |                              |      |      |
| Ductility factor                                                                                                                     | $k_7$           | [-]                | 1,0                                  |      |      |      |      |      |                              |      |      |
| <b>Steel failure with lever arm</b>                                                                                                  |                 |                    |                                      |      |      |      |      |      |                              |      |      |
| Characteristic bending moment                                                                                                        | $M_{Rk,s}^0$    | [Nm]               | $1,2 \cdot W_{el} \cdot f_{uk}^{1)}$ |      |      |      |      |      |                              |      |      |
| Elastic section modulus                                                                                                              | $W_{el}$        | [mm <sup>3</sup> ] | 50                                   | 98   | 170  | 269  | 402  | 785  | 1534                         | 2155 | 3217 |
| Partial factor                                                                                                                       | $\gamma_{Ms,V}$ | [-]                | $1,5^{2)}$                           |      |      |      |      |      |                              |      |      |
| <b>Concrete pry-out failure</b>                                                                                                      |                 |                    |                                      |      |      |      |      |      |                              |      |      |
| Factor                                                                                                                               | $k_8$           | [-]                | 2,0                                  |      |      |      |      |      |                              |      |      |
| Installation factor                                                                                                                  | $\gamma_{inst}$ | [-]                | 1,0                                  |      |      |      |      |      |                              |      |      |
| <b>Concrete edge failure</b>                                                                                                         |                 |                    |                                      |      |      |      |      |      |                              |      |      |
| Effective length of fastener                                                                                                         | $l_f$           | [mm]               | $\min(h_{ef}; 12 \cdot d_{nom})$     |      |      |      |      |      | $\min(h_{ef}; 300\text{mm})$ |      |      |
| Outside diameter of fastener                                                                                                         | $d_{nom}$       | [mm]               | 8                                    | 10   | 12   | 14   | 16   | 20   | 25                           | 28   | 32   |
| Installation factor                                                                                                                  | $\gamma_{inst}$ | [-]                | 1,0                                  |      |      |      |      |      |                              |      |      |
| <sup>1)</sup> $f_{uk}$ shall be taken from the specifications of reinforcing bars<br><sup>2)</sup> in absence of national regulation |                 |                    |                                      |      |      |      |      |      |                              |      |      |
| <b>Injection System ESSVE ONE, ESSVE ONE-ICE for concrete</b>                                                                        |                 |                    |                                      |      |      |      |      |      | <b>Annex C 8</b>             |      |      |
| <b>Performances</b><br>Characteristic values of shear loads under static and quasi-static action                                     |                 |                    |                                      |      |      |      |      |      |                              |      |      |

| <b>Table C9: Displacements under tension load<sup>1)</sup> (threaded rod)</b>                                                                                                                               |                            |                           |           |            |            |            |            |                  |            |            |
|-------------------------------------------------------------------------------------------------------------------------------------------------------------------------------------------------------------|----------------------------|---------------------------|-----------|------------|------------|------------|------------|------------------|------------|------------|
| <b>Anchor size threaded rod</b>                                                                                                                                                                             |                            |                           | <b>M8</b> | <b>M10</b> | <b>M12</b> | <b>M16</b> | <b>M20</b> | <b>M24</b>       | <b>M27</b> | <b>M30</b> |
| <b>Non-cracked concrete C20/25 under static and quasi-static action</b>                                                                                                                                     |                            |                           |           |            |            |            |            |                  |            |            |
| Temperature range<br>I: 40°C/24°C                                                                                                                                                                           | $\delta_{N0}$ -factor      | [mm/(N/mm <sup>2</sup> )] | 0,021     | 0,023      | 0,026      | 0,031      | 0,036      | 0,041            | 0,045      | 0,049      |
|                                                                                                                                                                                                             | $\delta_{N\infty}$ -factor | [mm/(N/mm <sup>2</sup> )] | 0,030     | 0,033      | 0,037      | 0,045      | 0,052      | 0,060            | 0,065      | 0,071      |
| Temperature range<br>II: 80°C/50°C                                                                                                                                                                          | $\delta_{N0}$ -factor      | [mm/(N/mm <sup>2</sup> )] | 0,050     | 0,056      | 0,063      | 0,075      | 0,088      | 0,100            | 0,110      | 0,119      |
|                                                                                                                                                                                                             | $\delta_{N\infty}$ -factor | [mm/(N/mm <sup>2</sup> )] | 0,072     | 0,081      | 0,090      | 0,108      | 0,127      | 0,145            | 0,159      | 0,172      |
| Temperature range<br>III: 120°C/72°C                                                                                                                                                                        | $\delta_{N0}$ -factor      | [mm/(N/mm <sup>2</sup> )] | 0,050     | 0,056      | 0,063      | 0,075      | 0,088      | 0,100            | 0,110      | 0,119      |
|                                                                                                                                                                                                             | $\delta_{N\infty}$ -factor | [mm/(N/mm <sup>2</sup> )] | 0,072     | 0,081      | 0,090      | 0,108      | 0,127      | 0,145            | 0,159      | 0,172      |
| <b>Cracked concrete C20/25 under static and quasi-static action</b>                                                                                                                                         |                            |                           |           |            |            |            |            |                  |            |            |
| Temperature range<br>I: 40°C/24°C                                                                                                                                                                           | $\delta_{N0}$ -factor      | [mm/(N/mm <sup>2</sup> )] | 0,090     |            | 0,070      |            |            |                  |            |            |
|                                                                                                                                                                                                             | $\delta_{N\infty}$ -factor | [mm/(N/mm <sup>2</sup> )] | 0,105     |            | 0,105      |            |            |                  |            |            |
| Temperature range<br>II: 80°C/50°C                                                                                                                                                                          | $\delta_{N0}$ -factor      | [mm/(N/mm <sup>2</sup> )] | 0,219     |            | 0,170      |            |            |                  |            |            |
|                                                                                                                                                                                                             | $\delta_{N\infty}$ -factor | [mm/(N/mm <sup>2</sup> )] | 0,255     |            | 0,245      |            |            |                  |            |            |
| Temperature range<br>III: 120°C/72°C                                                                                                                                                                        | $\delta_{N0}$ -factor      | [mm/(N/mm <sup>2</sup> )] | 0,219     |            | 0,170      |            |            |                  |            |            |
|                                                                                                                                                                                                             | $\delta_{N\infty}$ -factor | [mm/(N/mm <sup>2</sup> )] | 0,255     |            | 0,245      |            |            |                  |            |            |
| <sup>1)</sup> Calculation of the displacement<br>$\delta_{N0} = \delta_{N0}$ -factor $\cdot \tau$ ; $\tau$ : action bond stress for tension<br>$\delta_{N\infty} = \delta_{N\infty}$ -factor $\cdot \tau$ ; |                            |                           |           |            |            |            |            |                  |            |            |
| <b>Table C10: Displacements under shear load<sup>1)</sup> (threaded rod)</b>                                                                                                                                |                            |                           |           |            |            |            |            |                  |            |            |
| <b>Anchor size threaded rod</b>                                                                                                                                                                             |                            |                           | <b>M8</b> | <b>M10</b> | <b>M12</b> | <b>M16</b> | <b>M20</b> | <b>M24</b>       | <b>M27</b> | <b>M30</b> |
| <b>Non-cracked concrete C20/25 under static and quasi-static action</b>                                                                                                                                     |                            |                           |           |            |            |            |            |                  |            |            |
| All temperature<br>ranges                                                                                                                                                                                   | $\delta_{V0}$ -factor      | [mm/kN]                   | 0,06      | 0,06       | 0,05       | 0,04       | 0,04       | 0,03             | 0,03       | 0,03       |
|                                                                                                                                                                                                             | $\delta_{V\infty}$ -factor | [mm/kN]                   | 0,09      | 0,08       | 0,08       | 0,06       | 0,06       | 0,05             | 0,05       | 0,05       |
| <b>Cracked concrete C20/25 under static and quasi-static action</b>                                                                                                                                         |                            |                           |           |            |            |            |            |                  |            |            |
| All temperature<br>ranges                                                                                                                                                                                   | $\delta_{V0}$ -factor      | [mm/kN]                   | 0,12      | 0,12       | 0,11       | 0,10       | 0,09       | 0,08             | 0,08       | 0,07       |
|                                                                                                                                                                                                             | $\delta_{V\infty}$ -factor | [mm/kN]                   | 0,18      | 0,18       | 0,17       | 0,15       | 0,14       | 0,13             | 0,12       | 0,10       |
| <sup>1)</sup> Calculation of the displacement<br>$\delta_{V0} = \delta_{V0}$ -factor $\cdot V$ ; $V$ : action shear load<br>$\delta_{V\infty} = \delta_{V\infty}$ -factor $\cdot V$ ;                       |                            |                           |           |            |            |            |            |                  |            |            |
| <b>Injection System ESSVE ONE, ESSVE ONE-ICE for concrete</b>                                                                                                                                               |                            |                           |           |            |            |            |            | <b>Annex C 9</b> |            |            |
| <b>Performances</b><br>Displacements (threaded rods)                                                                                                                                                        |                            |                           |           |            |            |            |            |                  |            |            |

| Table C11: Displacements under tension load <sup>1)</sup> (Internal threaded anchor rod)                                                                                                                            |                            |                           |       |       |        |        |                   |        |
|---------------------------------------------------------------------------------------------------------------------------------------------------------------------------------------------------------------------|----------------------------|---------------------------|-------|-------|--------|--------|-------------------|--------|
| Anchor size Internal threaded anchor rod                                                                                                                                                                            |                            |                           | IG-M6 | IG-M8 | IG-M10 | IG-M12 | IG-M16            | IG-M20 |
| <b>Non-cracked concrete C20/25 under static and quasi-static action</b>                                                                                                                                             |                            |                           |       |       |        |        |                   |        |
| Temperature range<br>I: 40°C/24°C                                                                                                                                                                                   | $\delta_{N0}$ -factor      | [mm/(N/mm <sup>2</sup> )] | 0,023 | 0,026 | 0,031  | 0,036  | 0,041             | 0,049  |
|                                                                                                                                                                                                                     | $\delta_{N\infty}$ -factor | [mm/(N/mm <sup>2</sup> )] | 0,033 | 0,037 | 0,045  | 0,052  | 0,060             | 0,071  |
| Temperature range<br>II: 80°C/50°C                                                                                                                                                                                  | $\delta_{N0}$ -factor      | [mm/(N/mm <sup>2</sup> )] | 0,056 | 0,063 | 0,075  | 0,088  | 0,100             | 0,119  |
|                                                                                                                                                                                                                     | $\delta_{N\infty}$ -factor | [mm/(N/mm <sup>2</sup> )] | 0,081 | 0,090 | 0,108  | 0,127  | 0,145             | 0,172  |
| Temperature range<br>III: 120°C/72°C                                                                                                                                                                                | $\delta_{N0}$ -factor      | [mm/(N/mm <sup>2</sup> )] | 0,056 | 0,063 | 0,075  | 0,088  | 0,100             | 0,119  |
|                                                                                                                                                                                                                     | $\delta_{N\infty}$ -factor | [mm/(N/mm <sup>2</sup> )] | 0,081 | 0,090 | 0,108  | 0,127  | 0,145             | 0,172  |
| <b>Cracked concrete C20/25 under static and quasi-static action</b>                                                                                                                                                 |                            |                           |       |       |        |        |                   |        |
| Temperature range<br>I: 40°C/24°C                                                                                                                                                                                   | $\delta_{N0}$ -factor      | [mm/(N/mm <sup>2</sup> )] | 0,090 | 0,070 |        |        |                   |        |
|                                                                                                                                                                                                                     | $\delta_{N\infty}$ -factor | [mm/(N/mm <sup>2</sup> )] | 0,105 | 0,105 |        |        |                   |        |
| Temperature range<br>II: 80°C/50°C                                                                                                                                                                                  | $\delta_{N0}$ -factor      | [mm/(N/mm <sup>2</sup> )] | 0,219 | 0,170 |        |        |                   |        |
|                                                                                                                                                                                                                     | $\delta_{N\infty}$ -factor | [mm/(N/mm <sup>2</sup> )] | 0,255 | 0,245 |        |        |                   |        |
| Temperature range<br>III: 120°C/72°C                                                                                                                                                                                | $\delta_{N0}$ -factor      | [mm/(N/mm <sup>2</sup> )] | 0,219 | 0,170 |        |        |                   |        |
|                                                                                                                                                                                                                     | $\delta_{N\infty}$ -factor | [mm/(N/mm <sup>2</sup> )] | 0,255 | 0,245 |        |        |                   |        |
| <sup>1)</sup> Calculation of the displacement<br>$\delta_{N0} = \delta_{N0}\text{-factor} \cdot \tau$ ; $\tau$ : action bond stress for tension<br>$\delta_{N\infty} = \delta_{N\infty}\text{-factor} \cdot \tau$ ; |                            |                           |       |       |        |        |                   |        |
| <b>Table C12: Displacements under shear load<sup>1)</sup> (Internal threaded anchor rod)</b>                                                                                                                        |                            |                           |       |       |        |        |                   |        |
| Anchor size Internal threaded anchor rod                                                                                                                                                                            |                            |                           | IG-M6 | IG-M8 | IG-M10 | IG-M12 | IG-M16            | IG-M20 |
| <b>Non-cracked and cracked concrete C20/25 under static and quasi-static action</b>                                                                                                                                 |                            |                           |       |       |        |        |                   |        |
| All temperature ranges                                                                                                                                                                                              | $\delta_{V0}$ -factor      | [mm/kN]                   | 0,07  | 0,06  | 0,06   | 0,05   | 0,04              | 0,04   |
|                                                                                                                                                                                                                     | $\delta_{V\infty}$ -factor | [mm/kN]                   | 0,10  | 0,09  | 0,08   | 0,08   | 0,06              | 0,06   |
| <sup>1)</sup> Calculation of the displacement<br>$\delta_{V0} = \delta_{V0}\text{-factor} \cdot V$ ; $V$ : action shear load<br>$\delta_{V\infty} = \delta_{V\infty}\text{-factor} \cdot V$ ;                       |                            |                           |       |       |        |        |                   |        |
| <b>Injection System ESSVE ONE, ESSVE ONE-ICE for concrete</b>                                                                                                                                                       |                            |                           |       |       |        |        | <b>Annex C 10</b> |        |
| <b>Performances</b><br>Displacements (Internal threaded anchor rod)                                                                                                                                                 |                            |                           |       |       |        |        |                   |        |

| <b>Table C13: Displacements under tension load<sup>1)</sup> (rebar)</b>                                                                                                                                     |                            |                           |            |             |             |             |             |             |                   |             |             |
|-------------------------------------------------------------------------------------------------------------------------------------------------------------------------------------------------------------|----------------------------|---------------------------|------------|-------------|-------------|-------------|-------------|-------------|-------------------|-------------|-------------|
| <b>Anchor size reinforcing bar</b>                                                                                                                                                                          |                            |                           | <b>Ø 8</b> | <b>Ø 10</b> | <b>Ø 12</b> | <b>Ø 14</b> | <b>Ø 16</b> | <b>Ø 20</b> | <b>Ø 25</b>       | <b>Ø 28</b> | <b>Ø 32</b> |
| <b>Non-cracked concrete C20/25 under static and quasi-static action</b>                                                                                                                                     |                            |                           |            |             |             |             |             |             |                   |             |             |
| Temperature range I: 40°C/24°C                                                                                                                                                                              | $\delta_{N0}$ -factor      | [mm/(N/mm <sup>2</sup> )] | 0,021      | 0,023       | 0,026       | 0,028       | 0,031       | 0,036       | 0,043             | 0,047       | 0,052       |
|                                                                                                                                                                                                             | $\delta_{N\infty}$ -factor | [mm/(N/mm <sup>2</sup> )] | 0,030      | 0,033       | 0,037       | 0,041       | 0,045       | 0,052       | 0,061             | 0,071       | 0,075       |
| Temperature range II: 80°C/50°C                                                                                                                                                                             | $\delta_{N0}$ -factor      | [mm/(N/mm <sup>2</sup> )] | 0,050      | 0,056       | 0,063       | 0,069       | 0,075       | 0,088       | 0,104             | 0,113       | 0,126       |
|                                                                                                                                                                                                             | $\delta_{N\infty}$ -factor | [mm/(N/mm <sup>2</sup> )] | 0,072      | 0,081       | 0,090       | 0,099       | 0,108       | 0,127       | 0,149             | 0,163       | 0,181       |
| Temperature range III: 120°C/72°C                                                                                                                                                                           | $\delta_{N0}$ -factor      | [mm/(N/mm <sup>2</sup> )] | 0,050      | 0,056       | 0,063       | 0,069       | 0,075       | 0,088       | 0,104             | 0,113       | 0,126       |
|                                                                                                                                                                                                             | $\delta_{N\infty}$ -factor | [mm/(N/mm <sup>2</sup> )] | 0,072      | 0,081       | 0,090       | 0,099       | 0,108       | 0,127       | 0,149             | 0,163       | 0,181       |
| <b>Cracked concrete C20/25 under static and quasi-static action</b>                                                                                                                                         |                            |                           |            |             |             |             |             |             |                   |             |             |
| Temperature range I: 40°C/24°C                                                                                                                                                                              | $\delta_{N0}$ -factor      | [mm/(N/mm <sup>2</sup> )] | 0,090      |             |             |             | 0,070       |             |                   |             |             |
|                                                                                                                                                                                                             | $\delta_{N\infty}$ -factor | [mm/(N/mm <sup>2</sup> )] | 0,105      |             |             |             | 0,105       |             |                   |             |             |
| Temperature range II: 80°C/50°C                                                                                                                                                                             | $\delta_{N0}$ -factor      | [mm/(N/mm <sup>2</sup> )] | 0,219      |             |             |             | 0,170       |             |                   |             |             |
|                                                                                                                                                                                                             | $\delta_{N\infty}$ -factor | [mm/(N/mm <sup>2</sup> )] | 0,255      |             |             |             | 0,245       |             |                   |             |             |
| Temperature range III: 120°C/72°C                                                                                                                                                                           | $\delta_{N0}$ -factor      | [mm/(N/mm <sup>2</sup> )] | 0,219      |             |             |             | 0,170       |             |                   |             |             |
|                                                                                                                                                                                                             | $\delta_{N\infty}$ -factor | [mm/(N/mm <sup>2</sup> )] | 0,255      |             |             |             | 0,245       |             |                   |             |             |
| <sup>1)</sup> Calculation of the displacement<br>$\delta_{N0} = \delta_{N0}$ -factor $\cdot \tau$ ; $\tau$ : action bond stress for tension<br>$\delta_{N\infty} = \delta_{N\infty}$ -factor $\cdot \tau$ ; |                            |                           |            |             |             |             |             |             |                   |             |             |
| <b>Table C14: Displacement under shear load<sup>1)</sup> (rebar)</b>                                                                                                                                        |                            |                           |            |             |             |             |             |             |                   |             |             |
| <b>Anchor size reinforcing bar</b>                                                                                                                                                                          |                            |                           | <b>Ø 8</b> | <b>Ø 10</b> | <b>Ø 12</b> | <b>Ø 14</b> | <b>Ø 16</b> | <b>Ø 20</b> | <b>Ø 25</b>       | <b>Ø 28</b> | <b>Ø 32</b> |
| <b>Non-cracked concrete C20/25 under static and quasi-static action</b>                                                                                                                                     |                            |                           |            |             |             |             |             |             |                   |             |             |
| All temperature ranges                                                                                                                                                                                      | $\delta_{V0}$ -factor      | [mm/kN]                   | 0,06       | 0,05        | 0,05        | 0,04        | 0,04        | 0,04        | 0,03              | 0,03        | 0,03        |
|                                                                                                                                                                                                             | $\delta_{V\infty}$ -factor | [mm/kN]                   | 0,09       | 0,08        | 0,08        | 0,06        | 0,06        | 0,05        | 0,05              | 0,04        | 0,04        |
| <b>Cracked concrete C20/25 under static and quasi-static action</b>                                                                                                                                         |                            |                           |            |             |             |             |             |             |                   |             |             |
| All temperature ranges                                                                                                                                                                                      | $\delta_{V0}$ -factor      | [mm/kN]                   | 0,12       | 0,12        | 0,11        | 0,11        | 0,10        | 0,09        | 0,08              | 0,07        | 0,06        |
|                                                                                                                                                                                                             | $\delta_{V\infty}$ -factor | [mm/kN]                   | 0,18       | 0,18        | 0,17        | 0,16        | 0,15        | 0,14        | 0,12              | 0,11        | 0,10        |
| <sup>1)</sup> Calculation of the displacement<br>$\delta_{V0} = \delta_{V0}$ -factor $\cdot V$ ; $V$ : action shear load<br>$\delta_{V\infty} = \delta_{V\infty}$ -factor $\cdot V$ ;                       |                            |                           |            |             |             |             |             |             |                   |             |             |
| <b>Injection System ESSVE ONE, ESSVE ONE-ICE for concrete</b>                                                                                                                                               |                            |                           |            |             |             |             |             |             | <b>Annex C 11</b> |             |             |
| <b>Performances</b><br>Displacements (rebar)                                                                                                                                                                |                            |                           |            |             |             |             |             |             |                   |             |             |

| <b>Table C15: Characteristic values of tension loads under seismic action (performance category C1)</b>      |                 |                                         |                  |                      |            |            |            |            |                               |                   |            |     |  |
|--------------------------------------------------------------------------------------------------------------|-----------------|-----------------------------------------|------------------|----------------------|------------|------------|------------|------------|-------------------------------|-------------------|------------|-----|--|
| <b>Anchor size threaded rod</b>                                                                              |                 |                                         |                  | <b>M8</b>            | <b>M10</b> | <b>M12</b> | <b>M16</b> | <b>M20</b> | <b>M24</b>                    | <b>M27</b>        | <b>M30</b> |     |  |
| <b>Steel failure</b>                                                                                         |                 |                                         |                  |                      |            |            |            |            |                               |                   |            |     |  |
| Characteristic tension resistance                                                                            |                 | $N_{Rk,s,eq}$                           | [kN]             | $1,0 \cdot N_{Rk,s}$ |            |            |            |            |                               |                   |            |     |  |
| Partial factor                                                                                               |                 | $\gamma_{Ms,N}$                         | [-]              | see Table C1         |            |            |            |            |                               |                   |            |     |  |
| <b>Combined pull-out and concrete failure</b>                                                                |                 |                                         |                  |                      |            |            |            |            |                               |                   |            |     |  |
| Characteristic bond resistance in non-cracked and cracked concrete C20/25                                    |                 |                                         |                  |                      |            |            |            |            |                               |                   |            |     |  |
| Temperature range                                                                                            | I: 40°C/24°C    | Dry, wet concrete                       | $\tau_{Rk,eq}$   | [N/mm <sup>2</sup> ] | 2,5        | 3,1        | 3,7        | 3,7        | 3,7                           | 3,8               | 4,5        | 4,5 |  |
|                                                                                                              | II: 80°C/50°C   |                                         |                  |                      | 1,6        | 2,2        | 2,7        | 2,7        | 2,7                           | 2,8               | 3,1        | 3,1 |  |
|                                                                                                              | III: 120°C/72°C |                                         |                  |                      | 1,3        | 1,6        | 2,0        | 2,0        | 2,0                           | 2,1               | 2,4        | 2,4 |  |
|                                                                                                              | I: 40°C/24°C    | flooded bore hole                       |                  |                      | 2,5        | 2,5        | 3,7        | 3,7        | No Performance Assessed (NPA) |                   |            |     |  |
|                                                                                                              | II: 80°C/50°C   |                                         |                  |                      | 1,6        | 1,9        | 2,7        | 2,7        |                               |                   |            |     |  |
|                                                                                                              | III: 120°C/72°C |                                         |                  |                      | 1,3        | 1,6        | 2,0        | 2,0        |                               |                   |            |     |  |
| Reduktion factor $\psi_{SUS}^0$ in cracked and non-cracked concrete C20/25                                   |                 |                                         |                  |                      |            |            |            |            |                               |                   |            |     |  |
| Temperature range                                                                                            | I: 40°C/24°C    | Dry, wet concrete and flooded bore hole | $\psi_{SUS}^0$   | [-]                  | 0,73       |            |            |            |                               |                   |            |     |  |
|                                                                                                              | II: 80°C/50°C   |                                         |                  |                      | 0,65       |            |            |            |                               |                   |            |     |  |
|                                                                                                              | III: 120°C/72°C |                                         |                  |                      | 0,57       |            |            |            |                               |                   |            |     |  |
| Increasing factors for concrete $\psi_c$                                                                     |                 |                                         | C25/30 to C50/60 |                      |            |            | 1,0        |            |                               |                   |            |     |  |
| <b>Concrete cone failure</b>                                                                                 |                 |                                         |                  |                      |            |            |            |            |                               |                   |            |     |  |
| Relevant parameter                                                                                           |                 |                                         |                  | see Table C2         |            |            |            |            |                               |                   |            |     |  |
| <b>Splitting</b>                                                                                             |                 |                                         |                  |                      |            |            |            |            |                               |                   |            |     |  |
| Relevant parameter                                                                                           |                 |                                         |                  | see Table C2         |            |            |            |            |                               |                   |            |     |  |
| <b>Installation factor</b>                                                                                   |                 |                                         |                  |                      |            |            |            |            |                               |                   |            |     |  |
| for dry and wet concrete                                                                                     |                 | $\gamma_{inst}$                         | [-]              | 1,0                  | 1,2        |            |            |            |                               |                   |            |     |  |
| for flooded bore hole                                                                                        |                 |                                         |                  | 1,4                  |            |            |            | NPA        |                               |                   |            |     |  |
| <b>Injection System ESSVE ONE, ESSVE ONE-ICE for concrete</b>                                                |                 |                                         |                  |                      |            |            |            |            |                               | <b>Annex C 12</b> |            |     |  |
| <b>Performances</b><br>Characteristic values of tension loads under seismic action (performance category C1) |                 |                                         |                  |                      |            |            |            |            |                               |                   |            |     |  |

| <b>Table C16: Characteristic values of shear loads under seismic action (performance category C1)</b>                                                              |                 |           |                                  |            |            |            |            |                              |            |    |
|--------------------------------------------------------------------------------------------------------------------------------------------------------------------|-----------------|-----------|----------------------------------|------------|------------|------------|------------|------------------------------|------------|----|
| <b>Anchor size threaded rod</b>                                                                                                                                    |                 | <b>M8</b> | <b>M10</b>                       | <b>M12</b> | <b>M16</b> | <b>M20</b> | <b>M24</b> | <b>M27</b>                   | <b>M30</b> |    |
| <b>Steel failure without lever arm</b>                                                                                                                             |                 |           |                                  |            |            |            |            |                              |            |    |
| Characteristic shear resistance (Seismic C1)                                                                                                                       | $V_{Rk,s,eq}$   | [kN]      | $0,70 \cdot V_{Rk,s}^0$          |            |            |            |            |                              |            |    |
| Partial factor                                                                                                                                                     | $\gamma_{Ms,V}$ | [-]       | see Table C1                     |            |            |            |            |                              |            |    |
| Ductility factor                                                                                                                                                   | $k_7$           | [-]       | 1,0                              |            |            |            |            |                              |            |    |
| <b>Steel failure with lever arm</b>                                                                                                                                |                 |           |                                  |            |            |            |            |                              |            |    |
| Characteristic bending moment                                                                                                                                      | $M_{Rk,s,eq}^0$ | [Nm]      | No Performance Assessed (NPA)    |            |            |            |            |                              |            |    |
| <b>Concrete pry-out failure</b>                                                                                                                                    |                 |           |                                  |            |            |            |            |                              |            |    |
| Factor                                                                                                                                                             | $k_8$           | [-]       | 2,0                              |            |            |            |            |                              |            |    |
| Installation factor                                                                                                                                                | $\gamma_{inst}$ | [-]       | 1,0                              |            |            |            |            |                              |            |    |
| <b>Concrete edge failure</b>                                                                                                                                       |                 |           |                                  |            |            |            |            |                              |            |    |
| Effective length of fastener                                                                                                                                       | $l_f$           | [mm]      | $\min(h_{ef}; 12 \cdot d_{nom})$ |            |            |            |            | $\min(h_{ef}; 300\text{mm})$ |            |    |
| Outside diameter of fastener                                                                                                                                       | $d_{nom}$       | [mm]      | 8                                | 10         | 12         | 16         | 20         | 24                           | 27         | 30 |
| Installation factor                                                                                                                                                | $\gamma_{inst}$ | [-]       | 1,0                              |            |            |            |            |                              |            |    |
| <b>Factor for annular gap</b>                                                                                                                                      | $\alpha_{gap}$  | [-]       | $0,5 (1,0)^{1)}$                 |            |            |            |            |                              |            |    |
| <sup>1)</sup> Value in brackets valid for filled annular gap between anchor and clearance hole in the fixture. Use of special filling washer Annex A 3 is required |                 |           |                                  |            |            |            |            |                              |            |    |
| <b>Injection System ESSVE ONE, ESSVE ONE-ICE for concrete</b>                                                                                                      |                 |           |                                  |            |            |            |            | <b>Annex C 13</b>            |            |    |
| <b>Performances</b><br>Characteristic values of shear loads under seismic action (performance category C1)                                                         |                 |           |                                  |            |            |            |            |                              |            |    |

| <b>Table C17: Characteristic values of tension loads under seismic action (performance category C1)</b>                              |                 |                                         |                                   |                      |      |      |      |      |      |                               |      |     |     |  |
|--------------------------------------------------------------------------------------------------------------------------------------|-----------------|-----------------------------------------|-----------------------------------|----------------------|------|------|------|------|------|-------------------------------|------|-----|-----|--|
| <b>Anchor size reinforcing bar</b>                                                                                                   |                 |                                         | Ø 8                               | Ø 10                 | Ø 12 | Ø 14 | Ø 16 | Ø 20 | Ø 25 | Ø 28                          | Ø 32 |     |     |  |
| <b>Steel failure</b>                                                                                                                 |                 |                                         |                                   |                      |      |      |      |      |      |                               |      |     |     |  |
| Characteristic tension resistance                                                                                                    | $N_{Rk,s,eq}$   | [kN]                                    | $1,0 \cdot A_s \cdot f_{uk}^{1)}$ |                      |      |      |      |      |      |                               |      |     |     |  |
| Cross section area                                                                                                                   | $A_s$           | [mm <sup>2</sup> ]                      | 50                                | 79                   | 113  | 154  | 201  | 314  | 491  | 616                           | 804  |     |     |  |
| Partial factor                                                                                                                       | $\gamma_{Ms,N}$ | [-]                                     | $1,4^{2)}$                        |                      |      |      |      |      |      |                               |      |     |     |  |
| <b>Combined pull-out and concrete failure</b>                                                                                        |                 |                                         |                                   |                      |      |      |      |      |      |                               |      |     |     |  |
| Characteristic bond resistance in non-cracked and cracked concrete C20/25                                                            |                 |                                         |                                   |                      |      |      |      |      |      |                               |      |     |     |  |
| Temperature range                                                                                                                    | I: 40°C/24°C    | Dry, wet concrete                       | $\tau_{Rk, eq}$                   | [N/mm <sup>2</sup> ] | 2,5  | 3,1  | 3,7  | 3,7  | 3,7  | 3,7                           | 3,8  | 4,5 | 4,5 |  |
|                                                                                                                                      | II: 80°C/50°C   |                                         |                                   |                      | 1,6  | 2,2  | 2,7  | 2,7  | 2,7  | 2,7                           | 2,8  | 3,1 | 3,1 |  |
|                                                                                                                                      | III: 120°C/72°C |                                         |                                   |                      | 1,3  | 1,6  | 2,0  | 2,0  | 2,0  | 2,0                           | 2,1  | 2,4 | 2,4 |  |
|                                                                                                                                      | I: 40°C/24°C    | flooded bore hole                       |                                   |                      | 2,5  | 2,5  | 3,7  | 3,7  | 3,7  | No Performance Assessed (NPA) |      |     |     |  |
|                                                                                                                                      | II: 80°C/50°C   |                                         |                                   |                      | 1,6  | 1,9  | 2,7  | 2,7  |      |                               |      |     |     |  |
|                                                                                                                                      | III: 120°C/72°C |                                         |                                   |                      | 1,3  | 1,6  | 2,0  | 2,0  |      |                               |      |     |     |  |
| Reduktion factor $\psi_{SUS}^0$ in cracked and non-cracked concrete C20/25                                                           |                 |                                         |                                   |                      |      |      |      |      |      |                               |      |     |     |  |
| Temperature range                                                                                                                    | I: 40°C/24°C    | Dry, wet concrete and flooded bore hole | $\psi_{SUS}^0$                    | [-]                  | 0,73 |      |      |      |      |                               |      |     |     |  |
|                                                                                                                                      | II: 80°C/50°C   |                                         |                                   |                      | 0,65 |      |      |      |      |                               |      |     |     |  |
|                                                                                                                                      | III: 120°C/72°C |                                         |                                   |                      | 0,57 |      |      |      |      |                               |      |     |     |  |
| Increasing factors for concrete $\psi_c$                                                                                             |                 |                                         | C25/30 to C50/60                  |                      |      |      | 1,0  |      |      |                               |      |     |     |  |
| <b>Concrete cone failure</b>                                                                                                         |                 |                                         |                                   |                      |      |      |      |      |      |                               |      |     |     |  |
| Relevant parameter                                                                                                                   |                 |                                         | see Table C2                      |                      |      |      |      |      |      |                               |      |     |     |  |
| <b>Splitting</b>                                                                                                                     |                 |                                         |                                   |                      |      |      |      |      |      |                               |      |     |     |  |
| Relevant parameter                                                                                                                   |                 |                                         | see Table C2                      |                      |      |      |      |      |      |                               |      |     |     |  |
| <b>Installation factor</b>                                                                                                           |                 |                                         |                                   |                      |      |      |      |      |      |                               |      |     |     |  |
| for dry and wet concrete                                                                                                             |                 |                                         | $\gamma_{inst}$                   | [-]                  | 1,2  | 1,2  |      |      |      |                               |      |     |     |  |
| for flooded bore hole                                                                                                                |                 |                                         |                                   |                      | 1,4  |      |      |      | NPA  |                               |      |     |     |  |
| <sup>1)</sup> $f_{uk}$ shall be taken from the specifications of reinforcing bars<br><sup>2)</sup> in absence of national regulation |                 |                                         |                                   |                      |      |      |      |      |      |                               |      |     |     |  |
| <b>Injection System ESSVE ONE, ESSVE ONE-ICE for concrete</b>                                                                        |                 |                                         |                                   |                      |      |      |      |      |      | <b>Annex C 14</b>             |      |     |     |  |
| <b>Performances</b><br>Characteristic values of tension loads under seismic action (performance category C1)                         |                 |                                         |                                   |                      |      |      |      |      |      |                               |      |     |     |  |

| <b>Table C18: Characteristic values of shear loads under seismic action (performance category C1)</b>                                                                                                                                                                                                      |                 |                    |                                    |      |      |      |      |      |                              |                   |     |
|------------------------------------------------------------------------------------------------------------------------------------------------------------------------------------------------------------------------------------------------------------------------------------------------------------|-----------------|--------------------|------------------------------------|------|------|------|------|------|------------------------------|-------------------|-----|
| <b>Anchor size reinforcing bar</b>                                                                                                                                                                                                                                                                         |                 | Ø 8                | Ø 10                               | Ø 12 | Ø 14 | Ø 16 | Ø 20 | Ø 25 | Ø 28                         | Ø 32              |     |
| <b>Steel failure without lever arm</b>                                                                                                                                                                                                                                                                     |                 |                    |                                    |      |      |      |      |      |                              |                   |     |
| Characteristic shear resistance                                                                                                                                                                                                                                                                            | $V_{Rk,s,eq}$   | [kN]               | $0,35 \cdot A_s \cdot f_{uk}^{2)}$ |      |      |      |      |      |                              |                   |     |
| Cross section area                                                                                                                                                                                                                                                                                         | $A_s$           | [mm <sup>2</sup> ] | 50                                 | 79   | 113  | 154  | 201  | 314  | 491                          | 616               | 804 |
| Partial factor                                                                                                                                                                                                                                                                                             | $\gamma_{Ms,V}$ | [-]                | 1,5 <sup>2)</sup>                  |      |      |      |      |      |                              |                   |     |
| Ductility factor                                                                                                                                                                                                                                                                                           | $k_7$           | [-]                | 1,0                                |      |      |      |      |      |                              |                   |     |
| <b>Steel failure with lever arm</b>                                                                                                                                                                                                                                                                        |                 |                    |                                    |      |      |      |      |      |                              |                   |     |
| Characteristic bending moment                                                                                                                                                                                                                                                                              | $M^0_{Rk,s,eq}$ | [Nm]               | No Performance Assessed (NPA)      |      |      |      |      |      |                              |                   |     |
| <b>Concrete pry-out failure</b>                                                                                                                                                                                                                                                                            |                 |                    |                                    |      |      |      |      |      |                              |                   |     |
| Factor                                                                                                                                                                                                                                                                                                     | $k_8$           | [-]                | 2,0                                |      |      |      |      |      |                              |                   |     |
| Installation factor                                                                                                                                                                                                                                                                                        | $\gamma_{inst}$ | [-]                | 1,0                                |      |      |      |      |      |                              |                   |     |
| <b>Concrete edge failure</b>                                                                                                                                                                                                                                                                               |                 |                    |                                    |      |      |      |      |      |                              |                   |     |
| Effective length of fastener                                                                                                                                                                                                                                                                               | $l_f$           | [mm]               | $\min(h_{ef}; 12 \cdot d_{nom})$   |      |      |      |      |      | $\min(h_{ef}; 300\text{mm})$ |                   |     |
| Outside diameter of fastener                                                                                                                                                                                                                                                                               | $d_{nom}$       | [mm]               | 8                                  | 10   | 12   | 14   | 16   | 20   | 25                           | 28                | 32  |
| Installation factor                                                                                                                                                                                                                                                                                        | $\gamma_{inst}$ | [-]                | 1,0                                |      |      |      |      |      |                              |                   |     |
| <b>Factor for annular gap</b>                                                                                                                                                                                                                                                                              | $\alpha_{gap}$  | [-]                | <b>0,5 (1,0)<sup>3)</sup></b>      |      |      |      |      |      |                              |                   |     |
| <sup>1)</sup> $f_{uk}$ shall be taken from the specifications of reinforcing bars<br><sup>2)</sup> in absence of national regulation<br><sup>3)</sup> Value in brackets valid for filled annular gap between anchor and clearance hole in the fixture. Use of special filling washer Annex A 3 is required |                 |                    |                                    |      |      |      |      |      |                              |                   |     |
| <b>Injection System ESSVE ONE, ESSVE ONE-ICE for concrete</b>                                                                                                                                                                                                                                              |                 |                    |                                    |      |      |      |      |      |                              | <b>Annex C 15</b> |     |
| <b>Performances</b><br>Characteristic values of shear loads under seismic action (performance category C1)                                                                                                                                                                                                 |                 |                    |                                    |      |      |      |      |      |                              |                   |     |



| <b>Table C19: Displacements under tension load<sup>1)</sup> (threaded rod)</b>                                                                                                                                      |                            |                           |       |      |      |      |       |      |                   |      |      |
|---------------------------------------------------------------------------------------------------------------------------------------------------------------------------------------------------------------------|----------------------------|---------------------------|-------|------|------|------|-------|------|-------------------|------|------|
| Anchor size threaded rod                                                                                                                                                                                            |                            |                           | M8    | M10  | M12  | M16  | M20   | M24  | M27               | M30  |      |
| <b>Cracked and non-cracked concrete C20/25 under seismic C1 action</b>                                                                                                                                              |                            |                           |       |      |      |      |       |      |                   |      |      |
| Temperature range<br>I: 40°C/24°C                                                                                                                                                                                   | $\delta_{N0}$ -factor      | [mm/(N/mm <sup>2</sup> )] | 0,090 |      |      |      | 0,070 |      |                   |      |      |
|                                                                                                                                                                                                                     | $\delta_{N\infty}$ -factor | [mm/(N/mm <sup>2</sup> )] | 0,105 |      |      |      | 0,105 |      |                   |      |      |
| Temperature range<br>II: 80°C/50°C                                                                                                                                                                                  | $\delta_{N0}$ -factor      | [mm/(N/mm <sup>2</sup> )] | 0,219 |      |      |      | 0,170 |      |                   |      |      |
|                                                                                                                                                                                                                     | $\delta_{N\infty}$ -factor | [mm/(N/mm <sup>2</sup> )] | 0,255 |      |      |      | 0,245 |      |                   |      |      |
| Temperature range<br>III: 120°C/72°C                                                                                                                                                                                | $\delta_{N0}$ -factor      | [mm/(N/mm <sup>2</sup> )] | 0,219 |      |      |      | 0,170 |      |                   |      |      |
|                                                                                                                                                                                                                     | $\delta_{N\infty}$ -factor | [mm/(N/mm <sup>2</sup> )] | 0,255 |      |      |      | 0,245 |      |                   |      |      |
| <b>Table C20: Displacements under tension load<sup>1)</sup> (rebar)</b>                                                                                                                                             |                            |                           |       |      |      |      |       |      |                   |      |      |
| Anchor size reinforcing bar                                                                                                                                                                                         |                            |                           | Ø 8   | Ø 10 | Ø 12 | Ø 14 | Ø 16  | Ø 20 | Ø 25              | Ø 28 | Ø 32 |
| <b>Cracked and non-cracked concrete C20/25 under seismic C1 action</b>                                                                                                                                              |                            |                           |       |      |      |      |       |      |                   |      |      |
| Temperature range<br>I: 40°C/24°C                                                                                                                                                                                   | $\delta_{N0}$ -factor      | [mm/(N/mm <sup>2</sup> )] | 0,090 |      |      |      | 0,070 |      |                   |      |      |
|                                                                                                                                                                                                                     | $\delta_{N\infty}$ -factor | [mm/(N/mm <sup>2</sup> )] | 0,105 |      |      |      | 0,105 |      |                   |      |      |
| Temperature range<br>II: 80°C/50°C                                                                                                                                                                                  | $\delta_{N0}$ -factor      | [mm/(N/mm <sup>2</sup> )] | 0,219 |      |      |      | 0,170 |      |                   |      |      |
|                                                                                                                                                                                                                     | $\delta_{N\infty}$ -factor | [mm/(N/mm <sup>2</sup> )] | 0,255 |      |      |      | 0,245 |      |                   |      |      |
| Temperature range<br>III: 120°C/72°C                                                                                                                                                                                | $\delta_{N0}$ -factor      | [mm/(N/mm <sup>2</sup> )] | 0,219 |      |      |      | 0,170 |      |                   |      |      |
|                                                                                                                                                                                                                     | $\delta_{N\infty}$ -factor | [mm/(N/mm <sup>2</sup> )] | 0,255 |      |      |      | 0,245 |      |                   |      |      |
| <sup>1)</sup> Calculation of the displacement<br>$\delta_{N0} = \delta_{N0}\text{-factor} \cdot \tau$ ; $\tau$ : action bond stress for tension<br>$\delta_{N\infty} = \delta_{N\infty}\text{-factor} \cdot \tau$ ; |                            |                           |       |      |      |      |       |      |                   |      |      |
| <b>Table C21: Displacements under shear load<sup>2)</sup> (threaded rod)</b>                                                                                                                                        |                            |                           |       |      |      |      |       |      |                   |      |      |
| Anchor size threaded rod                                                                                                                                                                                            |                            |                           | M8    | M10  | M12  | M16  | M20   | M24  | M27               | M30  |      |
| <b>Cracked and non-cracked concrete C20/25 under seismic C1 action</b>                                                                                                                                              |                            |                           |       |      |      |      |       |      |                   |      |      |
| All temperature ranges                                                                                                                                                                                              | $\delta_{V0}$ -factor      | [mm/kN]                   | 0,12  | 0,12 | 0,11 | 0,10 | 0,09  | 0,08 | 0,08              | 0,07 |      |
|                                                                                                                                                                                                                     | $\delta_{V\infty}$ -factor | [mm/kN]                   | 0,18  | 0,18 | 0,17 | 0,15 | 0,14  | 0,13 | 0,12              | 0,10 |      |
| <b>Table C22: Displacement under shear load<sup>1)</sup> (rebar)</b>                                                                                                                                                |                            |                           |       |      |      |      |       |      |                   |      |      |
| Anchor size reinforcing bar                                                                                                                                                                                         |                            |                           | Ø 8   | Ø 10 | Ø 12 | Ø 14 | Ø 16  | Ø 20 | Ø 25              | Ø 28 | Ø 32 |
| <b>Cracked and non-cracked concrete C20/25 under seismic C1 action</b>                                                                                                                                              |                            |                           |       |      |      |      |       |      |                   |      |      |
| All temperature ranges                                                                                                                                                                                              | $\delta_{V0}$ -factor      | [mm/kN]                   | 0,12  | 0,12 | 0,11 | 0,11 | 0,10  | 0,09 | 0,08              | 0,07 | 0,06 |
|                                                                                                                                                                                                                     | $\delta_{V\infty}$ -factor | [mm/kN]                   | 0,18  | 0,18 | 0,17 | 0,16 | 0,15  | 0,14 | 0,12              | 0,11 | 0,10 |
| <sup>1)</sup> Calculation of the displacement<br>$\delta_{V0} = \delta_{V0}\text{-factor} \cdot V$ ; $V$ : action shear load<br>$\delta_{V\infty} = \delta_{V\infty}\text{-factor} \cdot V$ ;                       |                            |                           |       |      |      |      |       |      |                   |      |      |
| <b>Injection System ESSVE ONE, ESSVE ONE-ICE for concrete</b>                                                                                                                                                       |                            |                           |       |      |      |      |       |      | <b>Annex C 16</b> |      |      |
| <b>Performances</b><br>Displacements under seismic C1 action (threaded rods and rebar)                                                                                                                              |                            |                           |       |      |      |      |       |      |                   |      |      |

Approval body for construction products  
and types of construction

Bautechnisches Prüfamt

An institution established by the Federal and  
Laender Governments



## European Technical Assessment

ETA-18/0642  
of 8 October 2018

English translation prepared by DIBt - Original version in German language

### General Part

Technical Assessment Body issuing the  
European Technical Assessment:

Deutsches Institut für Bautechnik

Trade name of the construction product

ESSVE Injection system ONE or ONE ICE for Masonry

Product family  
to which the construction product belongs

Metal Injection anchors for use in masonry

Manufacturer

ESSVE Produkter AB  
Esbogatan 14  
164 74 KISTA  
SCHWEDEN

Manufacturing plant

ESSVE Plant No. 671

This European Technical Assessment  
contains

61 pages including 3 annexes which form an integral part  
of this assessment

This European Technical Assessment is  
issued in accordance with Regulation (EU)  
No 305/2011, on the basis of

EAD 330076-00-0604

The European Technical Assessment is issued by the Technical Assessment Body in its official language. Translations of this European Technical Assessment in other languages shall fully correspond to the original issued document and shall be identified as such.

Communication of this European Technical Assessment, including transmission by electronic means, shall be in full. However, partial reproduction may only be made with the written consent of the issuing Technical Assessment Body. Any partial reproduction shall be identified as such.

This European Technical Assessment may be withdrawn by the issuing Technical Assessment Body, in particular pursuant to information by the Commission in accordance with Article 25(3) of Regulation (EU) No 305/2011.

**Specific Part**

**1 Technical description of the product**

The ESSVE Injection System ONE or ONE ICE for masonry is a bonded anchor (injection type) consisting of a mortar cartridge with injection mortar ESSVE ONE or ESSVE ONE ICE, a perforated sleeve and an anchor rod with hexagon nut and washer. The steel elements are made of zinc coated steel or stainless steel.

The anchor rod is placed into a drilled hole filled with injection mortar and is anchored via the bond between steel element, injection mortar and masonry and mechanical interlock.

The product description is given in Annex A.

**2 Specification of the intended use in accordance with the applicable European Assessment Document**

The performances given in Section 3 are only valid if the anchor is used in compliance with the specifications and conditions given in Annex B.

The verifications and assessment methods on which this European Technical Assessment is based lead to the assumption of a working life of the anchor of at least 50 years. The indications given on the working life cannot be interpreted as a guarantee given by the producer, but are to be regarded only as a means for choosing the right products in relation to the expected economically reasonable working life of the works.

**3 Performance of the product and references to the methods used for its assessment**

**3.1 Mechanical resistance and stability (BWR 1)**

| Essential characteristic             | Performance             |
|--------------------------------------|-------------------------|
| Characteristic values for resistance | See Annexes C 1 to C 45 |
| Displacements                        | See Annex C 5 to C 45   |

**3.2 Safety in case of fire (BWR 2)**

| Essential characteristic | Performance |
|--------------------------|-------------|
| Reaction to fire         | Class A1    |

**3.3 Hygiene, health and the environment (BWR 3)**

| Essential characteristic                                 | Performance             |
|----------------------------------------------------------|-------------------------|
| Content, emission and/or release of dangerous substances | No performance assessed |

**4 Assessment and verification of constancy of performance (AVCP) system applied, with reference to its legal base**

In accordance with the European Assessment Document EAD 330076-00-0604 the applicable European legal act is: [97/177/EC].

The system to be applied is: 1

**5 Technical details necessary for the implementation of the AVCP system, as provided for in the applicable European Assessment Document**

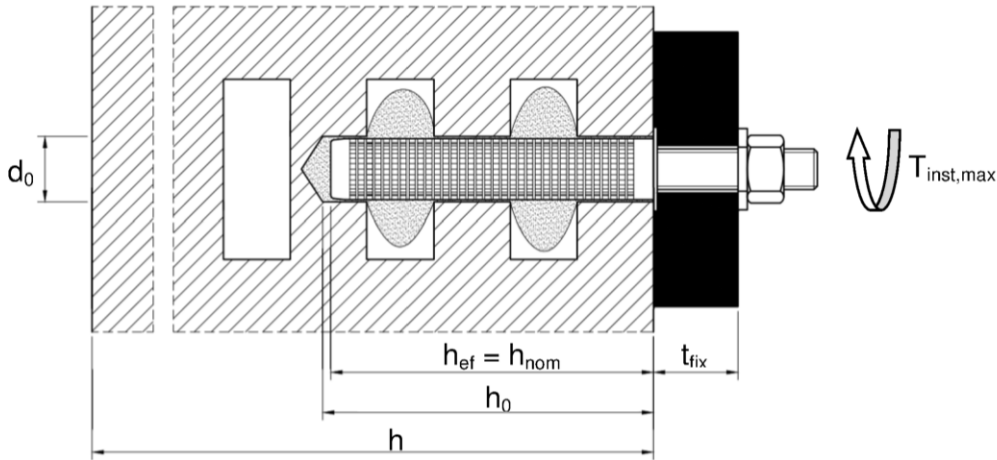
Technical details necessary for the implementation of the AVCP system are laid down in the control plan deposited at Deutsches Institut für Bautechnik.

Issued in Berlin on 8 October 2018 by Deutsches Institut für Bautechnik

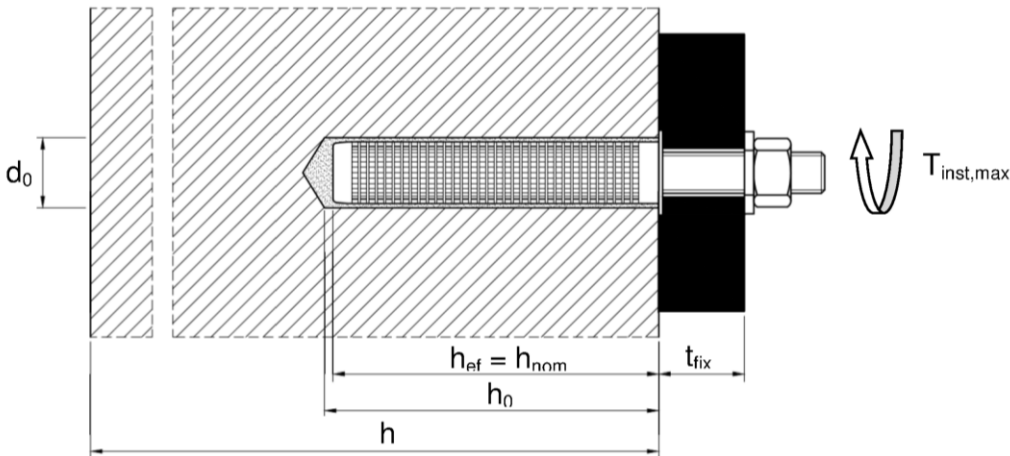
Dr.-Ing. Lars Eckfeldt  
p.p. Head of Department

*beglaubigt:*  
Baderschneider

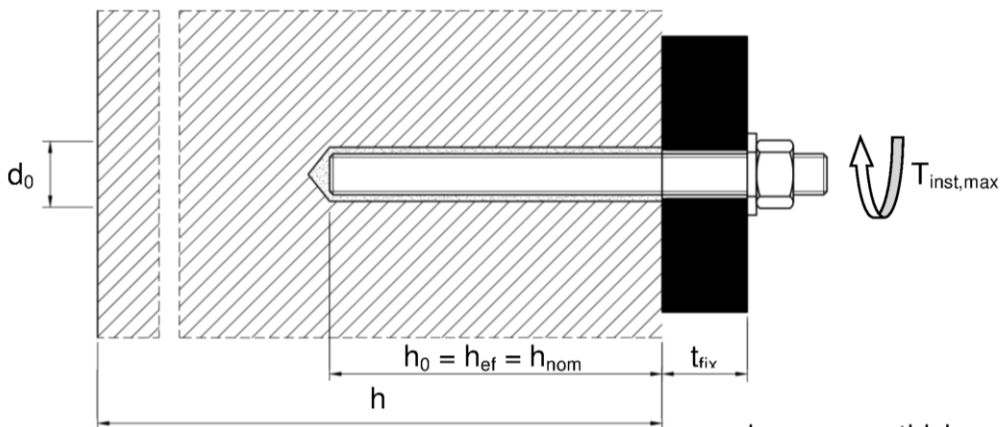
**Installation in hollow brick; threaded rod and Internal threaded rod with sleeve**



**Installation in solid brick; threaded rod and Internal threaded rod with sleeve**



**Installation in solid brick; threaded rod and Internal threaded rod without sleeve**



- |                                                 |                                               |
|-------------------------------------------------|-----------------------------------------------|
| $d_0$ = nominal drill hole diameter             | $h$ = thickness of member                     |
| $t_{fix}$ = thickness of fixture                | $h_0$ = depth of drill hole depth at shoulder |
| $T_{inst,max}$ = max installation torque moment | $h_{ef}$ = effective anchorage depth          |
|                                                 | $h_{nom}$ = overall embedment depth           |

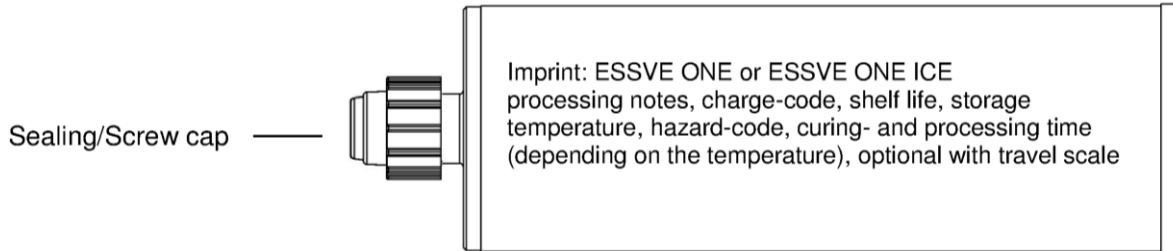
**ESSVE Injection system ONE, ONE ICE for masonry**

**Product description**  
Installed condition

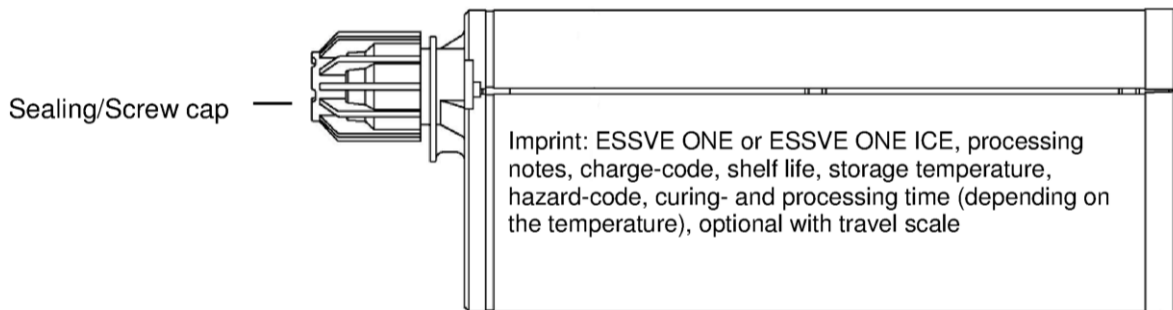
**Annex A 1**

### Cartridge: ESSVE ONE or ESSVE ONE ICE

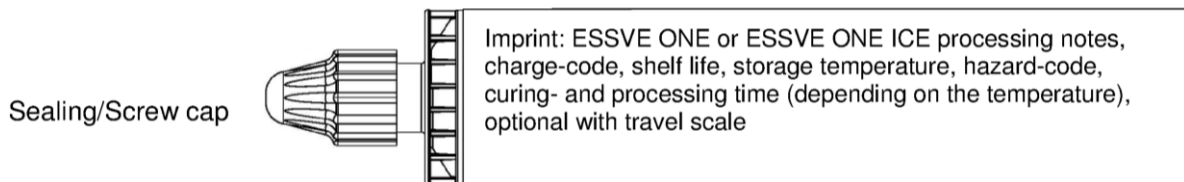
**150 ml, 280 ml, 300 ml up to 333 ml and 380 ml up to 420 ml cartridge (Type: coaxial)**



**235 ml, 345 ml up to 360 ml and 825 ml cartridge (Type: "side-by-side")**



**165 ml and 300 ml cartridge (Type: "foil tube")**



### Static Mixer

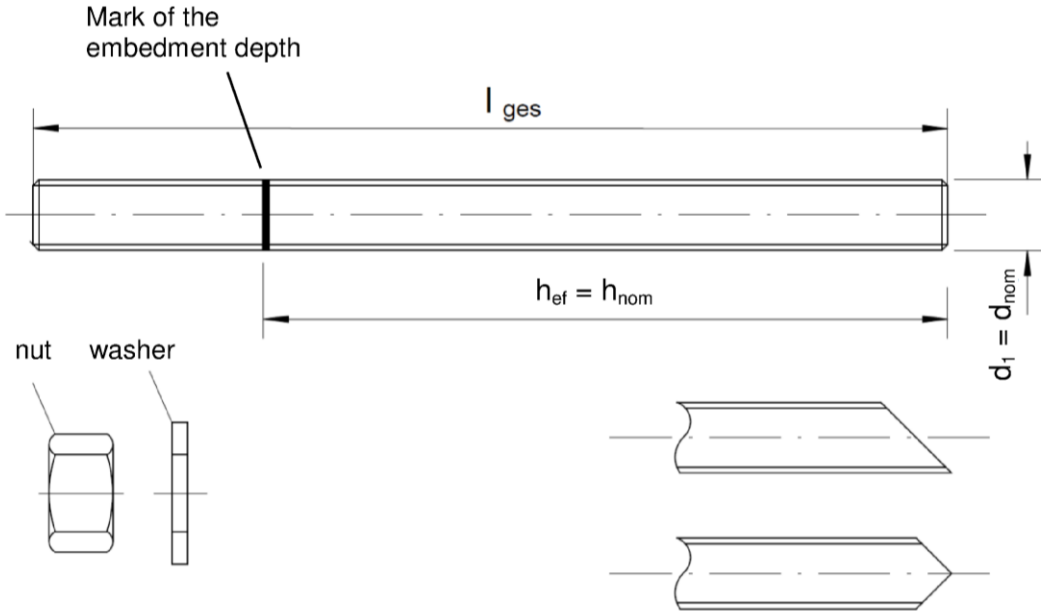


**ESSVE Injection system ONE, ONE ICE for masonry**

**Product description**  
Injection system

**Annex A 2**

### Threaded rod M8, M10, M12, M16

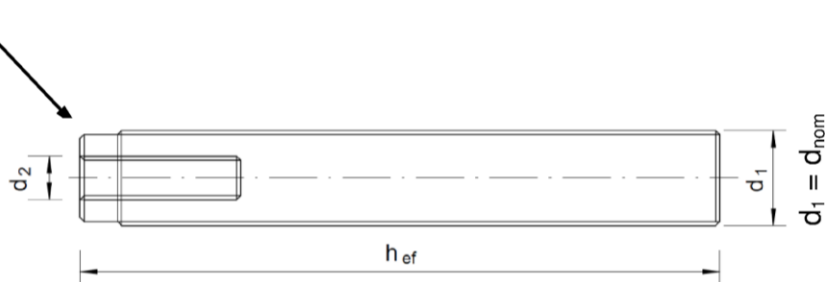



Commercial standard rod with:

- Materials, dimensions and mechanical properties acc. to Table A1
- Inspection certificate 3.1 acc. to EN 10204:2004. The document shall be stored.
- Marking of embedment depth

### Internal threaded rod IG-M6, IG-M8, IG-M10

Mark the producer



Marking: e.g.  M8

ESSVE Injection system ONE, ONE ICE for masonry

Product description  
Anchor rods

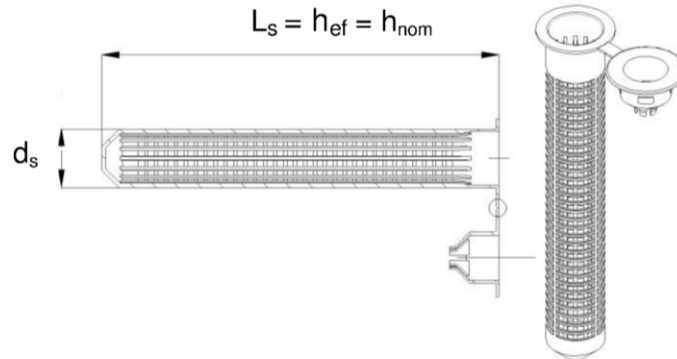
Annex A 3



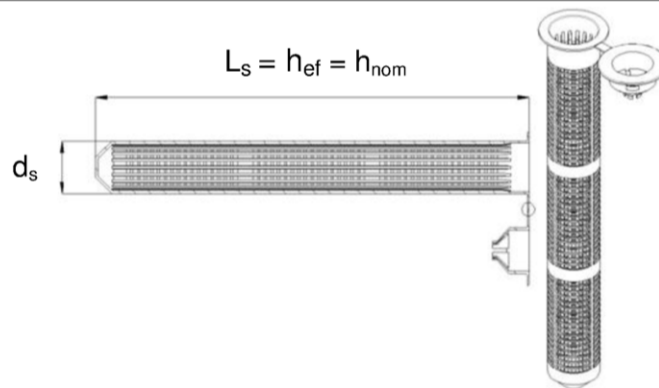
| <b>Table A1: Materials</b>                                                                                                                                                                              |                                                                                                                                                                                                                                   |
|---------------------------------------------------------------------------------------------------------------------------------------------------------------------------------------------------------|-----------------------------------------------------------------------------------------------------------------------------------------------------------------------------------------------------------------------------------|
| <b>Designation</b>                                                                                                                                                                                      | <b>Material</b>                                                                                                                                                                                                                   |
| <b>Steel, zinc plated <math>\geq 5 \mu\text{m}</math> acc. to EN ISO 4042:1999 or Steel, hot-dip galvanised <math>\geq 40 \mu\text{m}</math> acc. to EN ISO 1461:2009 and EN ISO 10684:2004+AC:2009</b> |                                                                                                                                                                                                                                   |
| Anchor rod                                                                                                                                                                                              | Steel, EN 10087:1998 or EN 10263:2001<br>Property class 4.6, 4.8, 5.6, 5.8, 8.8 acc.<br>EN 1993-1-8:2005+AC:2009<br>$A_s > 8\%$ fracture elongation                                                                               |
| Hexagon nut, EN ISO 4032:2012                                                                                                                                                                           | Steel acc. EN 10087:1998 or EN 10263:2001<br>Property class 4 (for class 4.6, 4.8 rod) EN ISO 898-2:2012<br>Property class 5 (for class 5.6, 5.8 rod) EN ISO 898-2:2012<br>Property class 8 (for class 8.8 rod) EN ISO 898-2:2012 |
| Washer, EN ISO 887:2006, EN ISO 7089:2000, EN ISO 7093:2000, or EN ISO 7094:2000                                                                                                                        | Steel, zinc plated or hot-dip galvanised                                                                                                                                                                                          |
| Internal threaded rod                                                                                                                                                                                   | Steel, zinc plated<br>Property class 5.6, 5.8 and 8.8 EN ISO 898-1:2013                                                                                                                                                           |
| <b>Stainless steel</b>                                                                                                                                                                                  |                                                                                                                                                                                                                                   |
| Anchor rod                                                                                                                                                                                              | Material 1.4401 / 1.4404 / 1.4571, EN 10088-1:2014,<br>Property class 70 EN ISO 3506-1:2009<br>Property class 80 EN ISO 3506-1:2009                                                                                               |
| Hexagon nut, EN ISO 4032:2012                                                                                                                                                                           | Material 1.4401 / 1.4404 / 1.4571 EN 10088-1:2014,<br>Property class 70 (for class 70 rod) EN ISO 3506-2:2009<br>Property class 80 (for class 80 rod) EN ISO 3506-2:2009                                                          |
| Washer, EN ISO 887:2006, EN ISO 7089:2000, EN ISO 7093:2000, or EN ISO 7094:2000                                                                                                                        | Material 1.4401, 1.4404 or 1.4571, EN 10088-1:2014                                                                                                                                                                                |
| Internal threaded rod                                                                                                                                                                                   | Stainless steel: 1.4401 / 1.4404 / 1.4571, EN 10088-1:2014<br>Property class 70 (for class 70 rod) EN ISO 3506-1:2009                                                                                                             |
| <b>High corrosion resistant steel (HCR)</b>                                                                                                                                                             |                                                                                                                                                                                                                                   |
| Anchor rod                                                                                                                                                                                              | Material 1.4529 / 1.4565, EN 10088-1:2014,<br>Property class 70 EN ISO 3506-1:2009<br>Property class 80 EN ISO 3506-1:2009                                                                                                        |
| Hexagon nut, EN ISO 4032:2012                                                                                                                                                                           | Material 1.4529 / 1.4565, EN 10088-1:2014,<br>Property class 70 (for class 70 rod) EN ISO 3506-2:2009<br>Property class 80 (for class 80 rod) EN ISO 3506-2:2009                                                                  |
| Washer, EN ISO 887:2006, EN ISO 7089:2000, EN ISO 7093:2000, or EN ISO 7094:2000                                                                                                                        | Material 1.4529 / 1.4565, EN 10088-1:2014                                                                                                                                                                                         |
| Internal threaded rod                                                                                                                                                                                   | Stainless steel: 1.4529 / 1.4565, EN 10088-1:2014<br>Property class 70 (for class 70 rod) EN ISO 3506-1:2009                                                                                                                      |
| <b>Plastic sleeve</b>                                                                                                                                                                                   |                                                                                                                                                                                                                                   |
| Perforated sleeve                                                                                                                                                                                       | Material: Polypropylene                                                                                                                                                                                                           |
| <br>                                                                                                                                                                                                    |                                                                                                                                                                                                                                   |
| <b>ESSVE Injection system ONE, ONE ICE for masonry</b>                                                                                                                                                  | <b>Annex A 4</b>                                                                                                                                                                                                                  |
| <b>Product description</b><br>Materials                                                                                                                                                                 |                                                                                                                                                                                                                                   |

**Table A2: Sleeve (Plastic)**

SH 12x80  
SH 16x85  
SH 20x85



SH 16x130  
SH 20x130  
SH 20x200



**Table A3: Sizes sleeve**

| Sleeve                    |                      | 12x80 | 16x85 | 16x130 | 20x85 | 20x130 | 20x200 |
|---------------------------|----------------------|-------|-------|--------|-------|--------|--------|
| Diameter of sleeve        | $d_s = d_{nom}$ [mm] | 12    | 16    | 16     | 20    | 20     | 20     |
| Length of sleeve          | $L_s$ [mm]           | 80    | 85    | 130    | 85    | 130    | 200    |
| Effective anchorage depth | $h_{ef}$ [mm]        | 80    | 85    | 130    | 85    | 130    | 200    |
| Overall anchor embedment  | $h_{nom}$ [mm]       | 80    | 85    | 130    | 85    | 130    | 200    |

**Table A4: Steel**

| Anchor rod                          |                      | IG-M6                                                          | IG-M8            | IG-M10           | M8                       | M10                       | M12                       | M16                       |
|-------------------------------------|----------------------|----------------------------------------------------------------|------------------|------------------|--------------------------|---------------------------|---------------------------|---------------------------|
| Outside diameter of anchor          | $d_1 = d_{nom}$ [mm] | 10 <sup>1)</sup>                                               | 12 <sup>1)</sup> | 16 <sup>1)</sup> | 8                        | 10                        | 12                        | 16                        |
| Diameter of internal thread         | $d_2$ [mm]           | 6                                                              | 8                | 10               | -                        | -                         | -                         | -                         |
| Thread engagement length<br>Min/max | $l_{IG}$ [mm]        | 8/20                                                           | 8/20             | 10/25            | -                        | -                         | -                         | -                         |
| Total length of steel element       | $l_{ges}$ [mm]       | With sleeve: $h_{ef} - 5\text{mm}$<br>Without sleeve: $h_{ef}$ |                  |                  | $h_{ef} + t_{fix} + 9,5$ | $h_{ef} + t_{fix} + 11,5$ | $h_{ef} + t_{fix} + 17,5$ | $h_{ef} + t_{fix} + 20,0$ |

<sup>1)</sup> Internal threaded rod with metric external thread

**ESSVE Injection system ONE, ONE ICE for masonry**

**Product description**  
Sleeves

**Annex A 5**

### Specifications of intended use

#### Anchorage subject to:

- Static and quasi-static loads

#### Base materials:

- Autoclaved Aerated Concrete (Use category d) according to Annex B2
- Solid brick masonry (Use category b), according to Annex B2.
- Hollow brick masonry (use category c), according to Annex B2 and B3
- Mortar strength class of the masonry M2,5 at minimum according to EN 998-2:2010.
- For other bricks in solid masonry and in hollow or perforated masonry, the characteristic resistance of the anchor may be determined by job site tests according to Technical Report TR 053 under consideration of the  $\beta$ -factor according to Annex C1, Table C1.

Note: The characteristic resistance for solid bricks and autoclaved aerated concrete are also valid for larger brick sizes and larger compressive strength of the masonry unit.

#### Temperature Range:

- $T_a$ : - 40°C to +40°C (max. short term temperature +40°C and max. long term temperature +24°C)
- $T_b$ : - 40°C to +80°C (max. short term temperature +80°C and max. long term temperature +50°C)
- $T_c$ : - 40°C to +120°C (max. short term temperature +120°C and max. long term temperature +72°C)

#### Use conditions (Environmental conditions):

- Dry and wet structure (regarding injection mortar).
- Structures subject to dry internal conditions (zinc coated steel, stainless steel or high corrosion resistant steel).
- Structures subject to external atmospheric exposure (including industrial and marine environment) and to permanently damp internal condition, if no particular aggressive conditions exist (stainless steel or high corrosion resistant steel).
- Structures subject to external atmospheric exposure and to permanently damp internal condition, if other particular aggressive conditions exist (high corrosion resistant steel).

Note: Particular aggressive conditions are e.g. permanent, alternating immersion in seawater or the splash zone of seawater, chloride atmosphere of indoor swimming pools or atmosphere with extreme chemical pollution (e.g. in desulphurization plants or road tunnels where de-icing materials are used).

#### Use categories in respect of installation and use:

- Category d/d: Installation and use in dry masonry
- Category w/w: Installation and use in dry or wet masonry (incl. w/d installation in wet masonry and use in dry masonry)

#### Design:

- Verifiable calculation notes and drawings are prepared taking account the relevant masonry in the region of the anchorage, the loads to be transmitted and their transmission to the supports of the structure. The position of the anchor is indicated on the design drawings.
- The anchorages are designed in accordance with the Technical Report TR 054, Design method A under the responsibility of an engineer experienced in anchorages and masonry work.
- $N_{Rk,p} = N_{Rk,b}$  see Annex C4 to C45;  $N_{Rk,s}$  see Annex C2;  $N_{Rk,pb}$  see Technical Report TR 054
- $V_{Rk,b}$  and  $V_{Rk,c}$  see Annex C4 to C45;  $V_{Rk,s}$  see Annex C2;  $V_{Rk,pb}$  see Technical Report TR 054
- For application with sleeve with drill bit size  $\leq 15$ mm installed in joints not filled with mortar:
  - $N_{Rk,p,j} = 0,18 * N_{Rk,p}$  and  $N_{Rk,b,j} = 0,18 * N_{Rk,b}$  ( $N_{Rk,p} = N_{Rk,b}$  see Annex C4 to C45)
  - $V_{Rk,c,j} = 0,15 * V_{Rk,c}$  and  $V_{Rk,b,j} = 0,15 * V_{Rk,b}$  ( $V_{Rk,b}$  and  $V_{Rk,c}$  see Annex C4 to C45)
- Application without sleeve installed in joints not filled with mortar is not allowed.




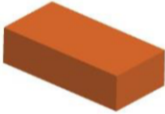

#### Installation:









- Dry or wet structures.
- Anchor Installation carried out by appropriately qualified personnel and under the supervision of the person responsible for technical matters of the site.
- Fastening screws or threaded rods (incl. nut and washer) must comply with the appropriate material and property class of the Internal threaded rod .

**ESSVE Injection system ONE, ONE ICE for masonry**

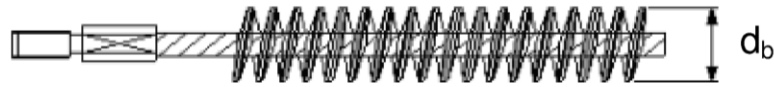
**Intended Use**  
Specifications

**Annex B 1**

| <b>Table B1: Overview brick types and properties with corresponding fastening elements (Anchor and Sleeves)</b> |                                        |                                                                                     |                           |                      |              |                                                                                                                                                                                                                      |           |
|-----------------------------------------------------------------------------------------------------------------|----------------------------------------|-------------------------------------------------------------------------------------|---------------------------|----------------------|--------------|----------------------------------------------------------------------------------------------------------------------------------------------------------------------------------------------------------------------|-----------|
| Brick-No.                                                                                                       | Brick type                             | Picture                                                                             | Brick size                | Compressive strength | Bulk density | Sleeve - Anchor type                                                                                                                                                                                                 | Annex     |
|                                                                                                                 |                                        |                                                                                     | length<br>width<br>height |                      |              |                                                                                                                                                                                                                      |           |
| <b>Autoclaved aerated concrete units according EN 771-4</b>                                                     |                                        |                                                                                     |                           |                      |              |                                                                                                                                                                                                                      |           |
| 1                                                                                                               | Autoclaved Aerated Concrete AAC6       |    | 499<br>240<br>249         | 6                    | 0,6          | M8/M10/M12/M16/IG-M6/IG-M8/IG-M10                                                                                                                                                                                    | C4 – C5   |
| <b>Calcium silicate masonry units according EN 771-2</b>                                                        |                                        |                                                                                     |                           |                      |              |                                                                                                                                                                                                                      |           |
| 2                                                                                                               | Calcium silicate solid brick KS-NF     |    | 240<br>115<br>71          | 10<br>20<br>27       | 2,0          | M8/M10/M12/M16/IG-M6/IG-M8/IG-M10<br>SH 12x80 – M8<br>SH 16x85 – M8/M10/IG-M6<br>SH 16x130 – M8/M10/IG-M6<br>SH 20x85 – M12/M16/IG-M8/IG-M10<br>SH 20x130 – M12/M16/IG-M8/IG-M10<br>SH 20x200 – M12/M16/IG-M8/IG-M10 | C6 – C8   |
| 3                                                                                                               | Calcium silicate hollow brick KSL-3DF  |  | 240<br>175<br>113         | 8<br>12<br>14        | 1,4          | SH 12x80 – M8<br>SH 16x85 – M8/M10/IG-M6<br>SH 16x130 – M8/M10/IG-M6<br>SH 20x85 – M12/M16/IG-M8/IG-M10<br>SH 20x130 – M12/M16/IG-M8/IG-M10<br>SH 20x200 – M12/M16/IG-M8/IG-M10                                      | C9 - C11  |
| 4                                                                                                               | Calcium silicate hollow brick KSL-12DF |  | 498<br>175<br>238         | 10<br>12<br>16       | 1,4          | SH 12x80 – M8<br>SH 16x85 – M8/M10/IG-M6<br>SH 16x130 – M8/M10/IG-M6<br>SH 20x85 – M12/M16/IG-M8/IG-M10<br>SH 20x130 – M12/M16/IG-M8/IG-M10                                                                          | C12 - C14 |
| <b>Clay masonry units according EN 771-1</b>                                                                    |                                        |                                                                                     |                           |                      |              |                                                                                                                                                                                                                      |           |
| 5                                                                                                               | Clay solid brick Mz – DF               |  | 240<br>115<br>55          | 10<br>20<br>28       | 1,6          | M8/M10/M12/M16/IG-M6/IG-M8/IG-M10<br>SH 12x80 – M8<br>SH 16x85 – M8/M10/IG-M6<br>SH 16x130 – M8/M10/IG-M6<br>SH 20x85 – M12/M16/IG-M8/IG-M10<br>SH 20x130 – M12/M16/IG-M8/IG-M10<br>SH 20x200 – M12/M16/IG-M8/IG-M10 | C15 - C17 |
| 6                                                                                                               | Clay hollow brick Hlz-16DF             |  | 497<br>240<br>238         | 6<br>8<br>12<br>14   | 0,8          | SH 12x80 – M8<br>SH 16x85 – M8/M10/IG-M6<br>SH 16x130 – M8/M10/IG-M6<br>SH 20x85 – M12/M16/IG-M8/IG-M10<br>SH 20x130 – M12/M16/IG-M8/IG-M10<br>SH 20x200 – M12/M16/IG-M8/IG-M10                                      | C18 - C20 |
| 7                                                                                                               | Clay hollow brick Porotherm Homebrick  |  | 500<br>200<br>299         | 4<br>6<br>10         | 0,7          | SH 12x80 – M8<br>SH 16x85 – M8/M10/IG-M6<br>SH 16x130 – M8/M10/IG-M6<br>SH 20x85 – M12/M16/IG-M8/IG-M10<br>SH 20x130 – M12/M16/IG-M8/IG-M10                                                                          | C21 - C23 |
| <b>ESSVE Injection system ONE, ONE ICE for masonry</b>                                                          |                                        |                                                                                     |                           |                      |              | <b>Annex B 2</b>                                                                                                                                                                                                     |           |
| <b>Intended Use</b><br>Brick types and properties with corresponding fastening elements                         |                                        |                                                                                     |                           |                      |              |                                                                                                                                                                                                                      |           |

| <b>Table B1: Overview brick types and properties with corresponding fastening elements (Anchor and Sleeves) (continue)</b> |                                                |                                                                                     |                                   |                      |              |                                                                                                                                                                                                                      |              |
|----------------------------------------------------------------------------------------------------------------------------|------------------------------------------------|-------------------------------------------------------------------------------------|-----------------------------------|----------------------|--------------|----------------------------------------------------------------------------------------------------------------------------------------------------------------------------------------------------------------------|--------------|
| Brick-No.                                                                                                                  | Brick type                                     | Picture                                                                             | Brick size                        | Compressive strength | Bulk density | Sleeve - Anchor type                                                                                                                                                                                                 | Annex        |
|                                                                                                                            |                                                |                                                                                     | length<br>width<br>height<br>[mm] |                      |              |                                                                                                                                                                                                                      |              |
| <b>Clay masonry units according EN 771-1</b>                                                                               |                                                |                                                                                     |                                   |                      |              |                                                                                                                                                                                                                      |              |
| 8                                                                                                                          | Clay hollow brick<br>BGV Thermo                |    | 500<br>200<br>314                 | 4<br>6<br>10         | 0,6          | SH 12x80 – M8<br>SH 16x85 – M8/M10/IG-M6<br>SH 16x130 – M8/M10/IG-M6<br>SH 20x85 – M12/M16/IG-M8/IG-M10<br>SH 20x130 – M12/M16/IG-M8/IG-M10                                                                          | C24 -<br>C26 |
| 9                                                                                                                          | Clay hollow brick<br>Calibric R+               |    | 500<br>200<br>314                 | 6<br>9<br>12         | 0,6          | SH 12x80 – M8<br>SH 16x85 – M8/M10/IG-M6<br>SH 16x130 – M8/M10/IG-M6<br>SH 20x85 – M12/M16/IG-M8/IG-M10<br>SH 20x130 – M12/M16/IG-M8/IG-M10                                                                          | C27-<br>C29  |
| 10                                                                                                                         | Clay hollow brick<br>Urbanbric                 |   | 560<br>200<br>274                 | 6<br>9<br>12         | 0,7          | SH 12x80 – M8<br>SH 16x85 – M8/M10/IG-M6<br>SH 16x130 – M8/M10/IG-M6<br>SH 20x85 – M12/M16/IG-M8/IG-M10<br>SH 20x130 – M12/M16/IG-M8/IG-M10                                                                          | C30 -<br>C32 |
| 11                                                                                                                         | Clay hollow brick<br>Brique creuse C40         |  | 500<br>200<br>200                 | 4<br>8<br>12         | 0,7          | SH 12x80 – M8<br>SH 16x85 – M8/M10/IG-M6<br>SH 16x130 – M8/M10/IG-M6<br>SH 20x85 – M12/M16/IG-M8/IG-M10<br>SH 20x130 – M12/M16/IG-M8/IG-M10                                                                          | C33 -<br>C35 |
| 12                                                                                                                         | Clay hollow brick<br>Blocchi Leggeri           |  | 250<br>120<br>250                 | 4<br>6<br>8<br>12    | 0,6          | SH 12x80 – M8<br>SH 16x85 – M8/M10/IG-M6<br>SH 16x130 – M8/M10/IG-M6<br>SH 20x85 – M12/M16/IG-M8/IG-M10<br>SH 20x130 – M12/M16/IG-M8/IG-M10<br>SH 20x200 – M12/M16/IG-M8/IG-M10                                      | C36 -<br>C38 |
| 13                                                                                                                         | Clay hollow brick<br>Doppio Uni                |  | 250<br>120<br>120                 | 10<br>16<br>20<br>28 | 0,9          | SH 12x80 – M8<br>SH 16x85 – M8/M10/IG-M6<br>SH 16x130 – M8/M10/IG-M6<br>SH 20x85 – M12/M16/IG-M8/IG-M10<br>SH 20x130 – M12/M16/IG-M8/IG-M10<br>SH 20x200 – M12/M16/IG-M8/IG-M10                                      | C39 -<br>C41 |
| <b>Light weight concrete according EN 771-3</b>                                                                            |                                                |                                                                                     |                                   |                      |              |                                                                                                                                                                                                                      |              |
| 14                                                                                                                         | Hollow light weight concrete<br>Bloc creux B40 |  | 494<br>200<br>190                 | 4                    | 0,8          | SH 12x80 – M8<br>SH 16x85 – M8/M10/IG-M6<br>SH 16x130 – M8/M10/IG-M6<br>SH 20x85 – M12/M16/IG-M8/IG-M10<br>SH 20x130 – M12/M16/IG-M8/IG-M10                                                                          | C42 -<br>C43 |
| 15                                                                                                                         | Solid light weight concrete                    |  | 300<br>123<br>248                 | 2                    | 0,6          | M8/M10/M12/M16/IG-M6/IG-M8/IG-M10<br>SH 12x80 – M8<br>SH 16x85 – M8/M10/IG-M6<br>SH 16x130 – M8/M10/IG-M6<br>SH 20x85 – M12/M16/IG-M8/IG-M10<br>SH 20x130 – M12/M16/IG-M8/IG-M10<br>SH 20x200 – M12/M16/IG-M8/IG-M10 | C44 -<br>C45 |
| <b>ESSVE Injection system ONE, ONE ICE for masonry</b>                                                                     |                                                |                                                                                     |                                   |                      |              | <b>Annex B 3</b>                                                                                                                                                                                                     |              |
| <b>Intended Use</b><br>Brick types and properties with corresponding fastening elements                                    |                                                |                                                                                     |                                   |                      |              |                                                                                                                                                                                                                      |              |

**Installation: Steel Brush RBT**



**Table B2: Installation parameters in autoclaved aerated concrete AAC and solid masonry (without sleeve)**

| Anchor size                               |                |      | M8               | M10   | IG-M6 | M12   | IG-M8 | M16   | IG-M10 |
|-------------------------------------------|----------------|------|------------------|-------|-------|-------|-------|-------|--------|
| Nominal drill hole diameter               | $d_0$          | [mm] | 10               | 12    |       | 14    |       | 18    |        |
| Drill hole depth                          | $h_0$          | [mm] | 80               | 90    |       | 100   |       | 100   |        |
| Effective anchorage depth                 | $h_{ef}$       | [mm] | 80               | 90    |       | 100   |       | 100   |        |
| Minimum wall thickness                    | $h_{min}$      | [mm] | $h_{ef} + 30$    |       |       |       |       |       |        |
| Diameter of clearance hole in the fixture | $d_f \leq$     | [mm] | 9                | 12    | 7     | 14    | 9     | 18    | 12     |
| Diameter of steel brush                   |                |      | RBT10            | RBT12 |       | RBT14 |       | RBT18 |        |
|                                           | $d_b$          | [mm] | 12               | 14    |       | 16    |       | 20    |        |
| Minimum diameter of steel brush           | $d_{b,min}$    | [mm] | 10,5             | 12,5  |       | 14,5  |       | 18,5  |        |
| Max installation torque moment            | $T_{inst,max}$ | [Nm] | 2 (14 for Mz DF) |       |       |       |       |       |        |

**Table B3: Installation parameters in solid and hollow masonry (with sleeve)**

| Anchor size                               |                |      | M8    | M8 / M10 / IG-M6              | M12 / M16 / IG-M8 / IG-M10 |                                               |        |        |
|-------------------------------------------|----------------|------|-------|-------------------------------|----------------------------|-----------------------------------------------|--------|--------|
| Sleeve                                    |                |      | 12x80 | 16x85                         | 16x130                     | 20x85                                         | 20x130 | 20x200 |
| Nominal drill hole diameter               | $d_0$          | [mm] | 12    | 16                            | 16                         | 20                                            | 20     | 20     |
| Drill hole depth                          | $h_0$          | [mm] | 85    | 90                            | 135                        | 90                                            | 135    | 205    |
| Effective anchorage depth                 | $h_{ef}$       | [mm] | 80    | 85                            | 130                        | 85                                            | 130    | 200    |
| Minimum wall thickness                    | $h_{min}$      | [mm] | 115   | 115                           | 175                        | 115                                           | 175    | 240    |
| Diameter of clearance hole in the fixture | $d_f \leq$     | [mm] | 9     | 7 (IG-M6) / 9 (M8) / 12 (M10) |                            | 9 (IG-M8) / 12 (IG-M10) / 14 (M12) / 18 (M16) |        |        |
| Diameter of steel brush                   |                |      | RBT12 | RBT16                         |                            | RBT20                                         |        |        |
|                                           | $d_b$          | [mm] | 14    | 18                            |                            | 22                                            |        |        |
| Minimum diameter of steel brush           | $d_{b,min}$    | [mm] | 12,5  | 16,5                          |                            | 20,5                                          |        |        |
| Max installation torque moment            | $T_{inst,max}$ | [Nm] | 2     |                               |                            |                                               |        |        |

**ESSVE Injection system ONE, ONE ICE for masonry**

**Intended Use**

Installation parameters and cleaning brush

**Annex B 4**

**Table B4: Maximum working time and minimum curing time  
ESSVE ONE**

| Temperature in the base material T | Temperature of cartridge | Gelling- / working time | Minimum curing time in dry base material <sup>1)</sup> |
|------------------------------------|--------------------------|-------------------------|--------------------------------------------------------|
| 0 °C to + 4 °C                     | +5°C to +40°C            | 45 min                  | 7 h                                                    |
| + 5 °C to + 9 °C                   |                          | 25 min                  | 2 h                                                    |
| + 10 °C to + 19 °C                 |                          | 15 min                  | 80 min                                                 |
| + 20 °C to + 29 °C                 |                          | 6 min                   | 45 min                                                 |
| + 30 °C to + 34 °C                 |                          | 4 min                   | 25 min                                                 |
| + 35 °C to + 39 °C                 |                          | 2 min                   | 20 min                                                 |
| + 40°C                             |                          | 1,5 min                 | 15 min                                                 |

<sup>1)</sup> In wet base material the curing time **must** be doubled

**Table B5: Maximum working time and minimum curing time  
ESSVE ONE ICE**

| Temperature in the base material T | Temperature of cartridge | Gelling- / working time | Minimum curing time in dry base material <sup>1)</sup> |
|------------------------------------|--------------------------|-------------------------|--------------------------------------------------------|
| 0 °C to + 4 °C                     | 0°C to +10°C             | 10 min                  | 2,5 h                                                  |
| + 5 °C to + 9 °C                   |                          | 6 min                   | 80 min                                                 |
| + 10°C                             |                          | 6 min                   | 60 min                                                 |

<sup>1)</sup> In wet base material the curing time **must** be doubled

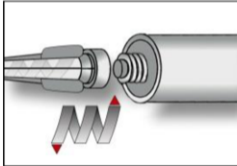
**ESSVE Injection system ONE, ONE ICE for masonry**

**Intended Use**  
Gelling and Curing times

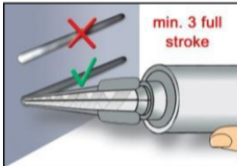
**Annex B 5**

## Installation Instructions

### Preparation of cartridge

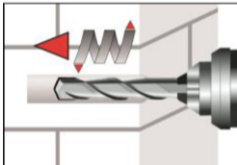


1. Remove the cap and attach the supplied static-mixing nozzle to the cartridge and load the cartridge into the correct dispensing tool. In case of a foil tube cartridge, cut off the clip before use. For every working interruption longer than the recommended working time (Annex B 5) as well as for new cartridges, a new static-mixer shall be used.

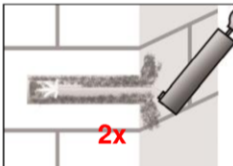
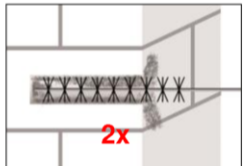
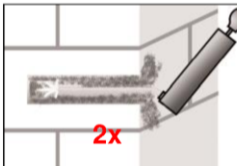


2. Initial adhesive is not suitable for fixing the anchor. Prior to dispensing into the anchor hole, squeeze out separately a minimum of three full strokes, for foil tube cartridges six full strokes and discard non-uniformly mixed adhesive components until the mortar shows a consistent grey colour.

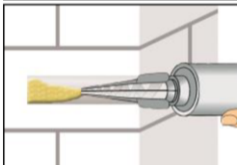
### Installation in solid masonry (without sleeve)



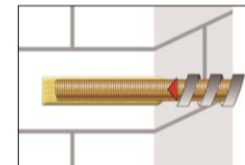
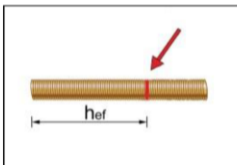
3. Holes to be drilled perpendicular to the surface of the base material by using a hard-metal tipped hammer drill bit. Drill a hole, with drilling method according to Annex C4-C45, into the base material, with nominal drill hole diameter and bore hole depth according to the size and embedment depth required by the selected anchor. In case of aborted drill hole the drill hole shall be filled with mortar.



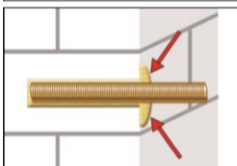
4. Blow out from the bottom of the bore hole two times. Attach the appropriate sized brush ( $> d_{b,min}$  Table B2 or B3) to a drilling machine or a battery screwdriver, brush the hole clean two times, and finally blow out the hole again two times.



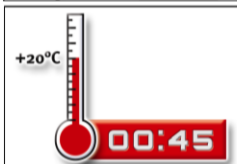
5. Starting from the bottom or back of the cleaned anchor hole, fill the hole up to min two-thirds with adhesive. Slowly withdraw the static mixing nozzle will avoid creating air pockets. Observe the gel-/ working times given in Annex B 5.



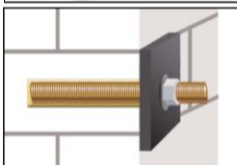
6. The position of the embedment depth shall be marked on the threaded rod. Push the threaded rod into the anchor hole while turning slightly to ensure positive distribution of the adhesive until the embedment depth is reached. The anchor shall be free of dirt, grease, oil or other foreign material.



7. Be sure that the annular gap is fully filled with mortar. If no excess mortar is visible at the top of the hole, the application has to be renewed.



8. Allow the adhesive to cure to the specified curing time prior to applying any load or torque. Do not move or load the anchor until it is fully cured (attend Annex B 5).



9. After full curing, the fixture can be installed with up to the max. installation torque (see Annex B4) by using a calibrated torque wrench.

ESSVE Injection system ONE, ONE ICE for masonry

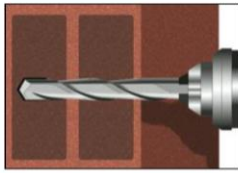
#### Intended Use

Installation instructions Solid masonry and Autoclaved Aerated Concrete

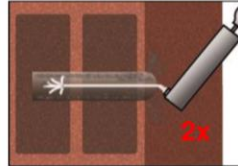
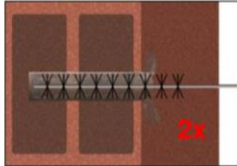
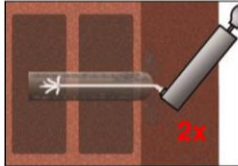
Annex B 6



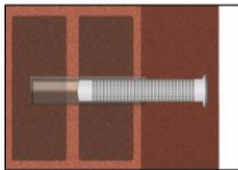
### Installation in solid and hollow masonry (with sleeve)



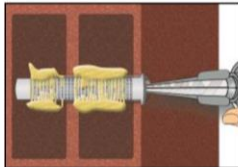
3. Holes to be drilled perpendicular to the surface of the base material by using a hard-metal tipped hammer drill bit. Drill a hole, with drill method according to Annex C4 – C45, into the base material, with nominal drill hole diameter and bore hole depth according to the size and embedment depth required by the selected anchor.



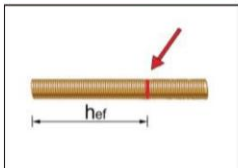
4. Blow out from the bottom of the bore hole two times. Attach the appropriate sized brush (>  $d_{b,min}$  Table B3) to a drilling machine or a battery screwdriver, brush the hole clean two times, and finally blow out the hole again two times.



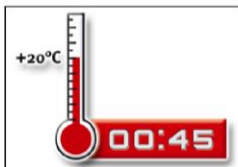
5. Insert the perforated sleeve flush with the surface of the masonry or plaster. Only use sleeves that have the right length. Never cut the sleeve.



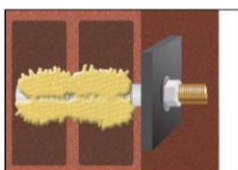
6. Starting from the bottom or back fill the sleeve with adhesive. For embedment depth equal to or larger than 130 mm an extension nozzle shall be used. For quantity of mortar attend cartridges label installation instructions. Observe the gel-/ working times given in Annex B 5.



7. The position of the embedment depth shall be marked on the threaded rod. Push the threaded rod into the anchor hole while turning slightly to ensure positive distribution of the adhesive until the embedment depth is reached. The anchor shall be free of dirt, grease, oil or other foreign material.



8. Allow the adhesive to cure to the specified curing time prior to applying any load or torque. Do not move or load the anchor until it is fully cured (attend Annex B 5).



9. After full curing, the fixture can be installed with up to the max. installation torque (see Annex B4) by using a calibrated torque wrench.

ESSVE Injection system ONE, ONE ICE for masonry

**Intended Use**

Installation instructions hollow brick

Annex B 7

**Table C1:  $\beta$ -factor for job-site testing under tension loading**

| Brick-No.<br>and<br>abbreviation  | Installation & Use<br>category | $\beta$ -factor                            |            |                                            |            |                                             |            |
|-----------------------------------|--------------------------------|--------------------------------------------|------------|--------------------------------------------|------------|---------------------------------------------|------------|
|                                   |                                | $T_a: 40^\circ\text{C} / 24^\circ\text{C}$ |            | $T_b: 80^\circ\text{C} / 50^\circ\text{C}$ |            | $T_c: 120^\circ\text{C} / 72^\circ\text{C}$ |            |
|                                   |                                | d/d                                        | w/d<br>w/w | d/d                                        | w/d<br>w/w | d/d                                         | w/d<br>w/w |
| 1<br>AAC6                         | For all sizes                  | 0,95                                       | 0,86       | 0,81                                       | 0,73       | 0,81                                        | 0,73       |
| 2<br>KS-NF                        | $d_0 \leq 14$ mm               | 0,93                                       | 0,80       | 0,87                                       | 0,74       | 0,65                                        | 0,56       |
|                                   | $d_0 \geq 16$ mm               | 0,93                                       | 0,93       | 0,87                                       | 0,87       | 0,65                                        | 0,65       |
| 3<br>KSL-3DF                      | $d_0 \leq 12$ mm               | 0,93                                       | 0,80       | 0,87                                       | 0,74       | 0,65                                        | 0,56       |
|                                   | $d_0 \geq 16$ mm               | 0,93                                       | 0,93       | 0,87                                       | 0,87       | 0,65                                        | 0,65       |
| 4<br>KSL-12DF                     | $d_0 \leq 12$ mm               | 0,93                                       | 0,80       | 0,87                                       | 0,74       | 0,65                                        | 0,56       |
|                                   | $d_0 \geq 16$ mm               | 0,93                                       | 0,93       | 0,87                                       | 0,87       | 0,65                                        | 0,65       |
| 5<br>MZ-DF                        | For all sizes                  | 0,86                                       | 0,86       | 0,86                                       | 0,86       | 0,73                                        | 0,73       |
| 6<br>Hz-16DF                      |                                |                                            |            |                                            |            |                                             |            |
| 7<br>Porotherm Homebric           |                                |                                            |            |                                            |            |                                             |            |
| 8<br>BGV-Thermo                   |                                |                                            |            |                                            |            |                                             |            |
| 9<br>Calibric R+                  |                                |                                            |            |                                            |            |                                             |            |
| 10<br>Urbanbric                   |                                |                                            |            |                                            |            |                                             |            |
| 11<br>Brique creuse C40           |                                |                                            |            |                                            |            |                                             |            |
| 12<br>Blocchi Leggeri             |                                |                                            |            |                                            |            |                                             |            |
| 13<br>Doppio Uni                  |                                |                                            |            |                                            |            |                                             |            |
| 14<br>Bloc creux B40              |                                |                                            |            |                                            |            |                                             |            |
| 15<br>Solid light weight concrete | $d_0 \leq 12$ mm               | 0,93                                       | 0,80       | 0,87                                       | 0,74       | 0,65                                        | 0,56       |
|                                   | $d_0 \geq 16$ mm               | 0,93                                       | 0,93       | 0,87                                       | 0,87       | 0,65                                        | 0,65       |

**ESSVE Injection system ONE, ONE ICE for masonry**

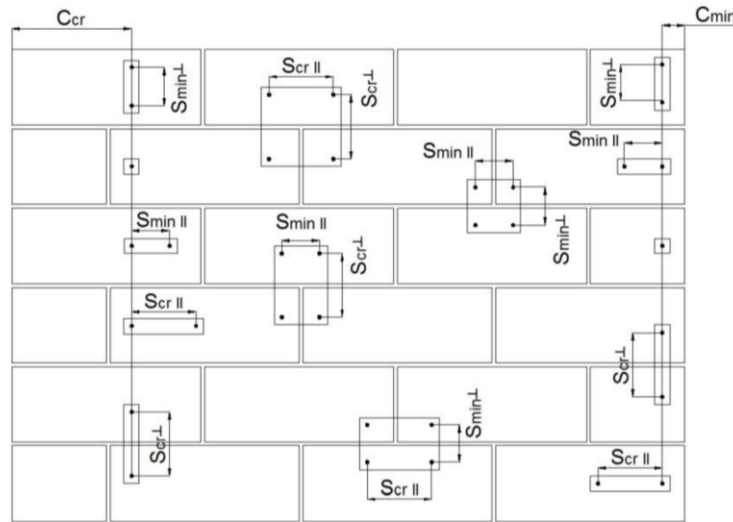
**Performances**

$\beta$ -factors for job site testing under tension load

**Annex C 1**

| <b>Table C2: Characteristic steel resistance</b>                                              |               |      |              |              |               |                  |            |            |            |
|-----------------------------------------------------------------------------------------------|---------------|------|--------------|--------------|---------------|------------------|------------|------------|------------|
| <b>Size</b>                                                                                   |               |      | <b>IG-M6</b> | <b>IG-M8</b> | <b>IG-M10</b> | <b>M8</b>        | <b>M10</b> | <b>M12</b> | <b>M16</b> |
| <b>Characteristic tension resistance</b>                                                      |               |      |              |              |               |                  |            |            |            |
| steel, property class 4.6                                                                     | $N_{Rk,s}$    | [kN] | -            | -            | -             | 15               | 23         | 34         | 63         |
|                                                                                               | $\gamma_{Ms}$ | [-]  | 2,0          |              |               |                  |            |            |            |
| steel, property class 4.8                                                                     | $N_{Rk,s}$    | [kN] | -            | -            | -             | 15               | 23         | 34         | 63         |
|                                                                                               | $\gamma_{Ms}$ | [-]  | 1,5          |              |               |                  |            |            |            |
| steel, property class 5.6                                                                     | $N_{Rk,s}$    | [kN] | 10           | 18           | 29            | 18               | 29         | 42         | 79         |
|                                                                                               | $\gamma_{Ms}$ | [-]  | 2,0          |              |               |                  |            |            |            |
| steel, property class 5.8                                                                     | $N_{Rk,s}$    | [kN] | 10           | 17           | 29            | 18               | 29         | 42         | 79         |
|                                                                                               | $\gamma_{Ms}$ | [-]  | 1,5          |              |               |                  |            |            |            |
| steel, property class 8.8                                                                     | $N_{Rk,s}$    | [kN] | 16           | 27           | 46            | 29               | 46         | 67         | 126        |
|                                                                                               | $\gamma_{Ms}$ | [-]  | 1,5          |              |               |                  |            |            |            |
| Stainless steel A4 / HCR, property class 70                                                   | $N_{Rk,s}$    | [kN] | 14           | 26           | 41            | 26               | 41         | 59         | 110        |
|                                                                                               | $\gamma_{Ms}$ | [-]  | 1,87         |              |               |                  |            |            |            |
| Stainless steel A4 / HCR, property class 80                                                   | $N_{Rk,s}$    | [kN] | 16           | 29           | 46            | 29               | 46         | 67         | 126        |
|                                                                                               | $\gamma_{Ms}$ | [-]  | 1,6          |              |               |                  |            |            |            |
| <b>Characteristic shear resistance</b>                                                        |               |      |              |              |               |                  |            |            |            |
| steel, property class 4.6                                                                     | $V_{Rk,s}$    | [kN] | -            | -            | -             | 7                | 12         | 17         | 31         |
|                                                                                               | $\gamma_{Ms}$ | [-]  | 1,67         |              |               |                  |            |            |            |
| steel, property class 4.8                                                                     | $V_{Rk,s}$    | [kN] | -            | -            | -             | 7                | 12         | 17         | 31         |
|                                                                                               | $\gamma_{Ms}$ | [-]  | 1,25         |              |               |                  |            |            |            |
| steel, property class 5.6                                                                     | $V_{Rk,s}$    | [kN] | 5            | 9            | 15            | 9                | 15         | 21         | 39         |
|                                                                                               | $\gamma_{Ms}$ | [-]  | 1,67         |              |               |                  |            |            |            |
| steel, property class 5.8                                                                     | $V_{Rk,s}$    | [kN] | 5            | 9            | 15            | 9                | 15         | 21         | 39         |
|                                                                                               | $\gamma_{Ms}$ | [-]  | 1,25         |              |               |                  |            |            |            |
| steel, property class 8.8                                                                     | $V_{Rk,s}$    | [kN] | 8            | 14           | 23            | 15               | 23         | 34         | 63         |
|                                                                                               | $\gamma_{Ms}$ | [-]  | 1,25         |              |               |                  |            |            |            |
| Stainless steel A4 / HCR, property class 70                                                   | $V_{Rk,s}$    | [kN] | 7            | 13           | 20            | 13               | 20         | 30         | 55         |
|                                                                                               | $\gamma_{Ms}$ | [-]  | 1,56         |              |               |                  |            |            |            |
| Stainless steel A4 / HCR, property class 80                                                   | $V_{Rk,s}$    | [kN] | 8            | 15           | 23            | 15               | 23         | 34         | 63         |
|                                                                                               | $\gamma_{Ms}$ | [-]  | 1,33         |              |               |                  |            |            |            |
| <b>Characteristic bending moment</b>                                                          |               |      |              |              |               |                  |            |            |            |
| steel, property class 4.6                                                                     | $M_{Rk,s}$    | [Nm] | -            | -            | -             | 15               | 30         | 52         | 133        |
|                                                                                               | $\gamma_{Ms}$ | [-]  | 1,67         |              |               |                  |            |            |            |
| steel, property class 4.8                                                                     | $M_{Rk,s}$    | [Nm] | -            | -            | -             | 15               | 30         | 52         | 133        |
|                                                                                               | $\gamma_{Ms}$ | [-]  | 1,25         |              |               |                  |            |            |            |
| steel, property class 5.6                                                                     | $M_{Rk,s}$    | [Nm] | 8            | 19           | 37            | 19               | 37         | 66         | 167        |
|                                                                                               | $\gamma_{Ms}$ | [-]  | 1,67         |              |               |                  |            |            |            |
| steel, property class 5.8                                                                     | $M_{Rk,s}$    | [Nm] | 8            | 19           | 37            | 19               | 37         | 66         | 167        |
|                                                                                               | $\gamma_{Ms}$ | [-]  | 1,25         |              |               |                  |            |            |            |
| steel, property class 8.8                                                                     | $M_{Rk,s}$    | [Nm] | 12           | 30           | 60            | 30               | 60         | 105        | 266        |
|                                                                                               | $\gamma_{Ms}$ | [-]  | 1,25         |              |               |                  |            |            |            |
| Stainless steel A4 / HCR, property class 70                                                   | $M_{Rk,s}$    | [Nm] | 11           | 26           | 52            | 26               | 52         | 92         | 233        |
|                                                                                               | $\gamma_{Ms}$ | [-]  | 1,56         |              |               |                  |            |            |            |
| Stainless steel A4 / HCR, property class 80                                                   | $M_{Rk,s}$    | [Nm] | 12           | 30           | 60            | 30               | 60         | 105        | 266        |
|                                                                                               | $\gamma_{Ms}$ | [-]  | 1,33         |              |               |                  |            |            |            |
| <b>ESSVE Injection system ONE, ONE ICE for masonry</b>                                        |               |      |              |              |               | <b>Annex C 2</b> |            |            |            |
| <b>Performances</b><br>Characteristic resistance under tension and shear load – steel failure |               |      |              |              |               |                  |            |            |            |

### Spacing and edge distances



- $C_{cr}$  = Characteristic edge distance
- $C_{min}$  = Minimum Edge distance
- $S_{cr}$  = Characteristic spacing
- $S_{min}$  = Minimum spacing
- $S_{cr,II}$ ; ( $S_{min,II}$ ) = Characteristic (minimum) spacing for anchors placed parallel to bed joint
- $S_{cr,\perp}$ ; ( $S_{min,\perp}$ ) = Characteristic (minimum) spacing for anchors placed perpendicular to bed joint

| Load direction<br>Anchor position                                              | Tension load | Shear load parallel to free edge | Shear load perpendicular to free edge |
|--------------------------------------------------------------------------------|--------------|----------------------------------|---------------------------------------|
| Anchors places parallel to bed joint $s_{cr,II}$ ; ( $s_{min,II}$ )            |              |                                  |                                       |
| Anchors places perpendicular to bed joint $s_{cr,\perp}$ ; ( $s_{min,\perp}$ ) |              |                                  |                                       |

- $\alpha_{g,N,II}$  = Group factor in case of tension load for anchors placed parallel to the bed joint
- $\alpha_{g,V,II}$  = Group factor in case of shear load for anchors placed parallel to the bed joint
- $\alpha_{g,N,\perp}$  = Group factor in case of tension load for anchors placed perpendicular to the bed joint
- $\alpha_{g,V,\perp}$  = Group factor in case of shear load for anchors placed perpendicular to the bed joint

Group of two anchors:  $N_{RK}^g = \alpha_{g,N} * N_{RK}$  and  $V_{RK}^g = \alpha_{g,V} * V_{RK}$

Group of four anchors:  $N_{RK}^g = \alpha_{g,N,II} * \alpha_{g,N,\perp} * N_{RK}$  and  $V_{RK}^g = \alpha_{g,V,II} * \alpha_{g,V,\perp} * V_{RK}$

( $N_{RK}$ :  $N_{RK,b}$  or  $N_{RK,b,j}$  for  $c_{cr}$ )  
 ( $V_{RK}$ :  $V_{RK,c}$ ;  $V_{RK,c,j}$ ;  $V_{RK,b}$  or  $V_{RK,b,j}$  for  $c_{cr}$ )  
 (with the relevant  $\alpha_g$ )

ESSVE Injection system ONE, ONE ICE for masonry


#### Performances

Edge distance and anchor spacing

Annex C 3

**Brick type: Autoclaved Aerated Concrete – AAC6**

**Table C3: Description of the brick**

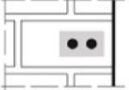
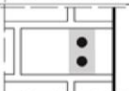
|                                                      |                                  |                                                                                     |
|------------------------------------------------------|----------------------------------|-------------------------------------------------------------------------------------|
| Brick type                                           | Autoclaved Aerated Concrete AAC6 |  |
| Bulk density $\rho$ [kg/dm <sup>3</sup> ]            | 0,6                              |                                                                                     |
| Compressive strength $f_b \geq$ [N/mm <sup>2</sup> ] | 6                                |                                                                                     |
| Code                                                 | EN 771-4                         |                                                                                     |
| Producer (country code)                              | e.g. Porit (DE)                  |                                                                                     |
| Brick dimensions [mm]                                | 499 x 240 x 249                  |                                                                                     |
| Drilling method                                      | Rotary                           |                                                                                     |

**Table C4: Installation parameter**

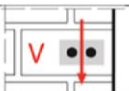
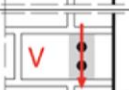
| Anchor size               |                                                    | [-]  | M8                  | M10/IG-M6 | M12/IG-M8 | M16/IG-M10 |
|---------------------------|----------------------------------------------------|------|---------------------|-----------|-----------|------------|
| Effective anchorage depth |                                                    | [mm] | 80                  | 90        | 100       | 100        |
| Edge distance             | $C_{cr}$                                           | [mm] | 1,5* $h_{ef}$       |           |           |            |
| Minimum edge distance     | $C_{min,N}$                                        | [mm] | 75                  |           |           |            |
|                           | $C_{min,V,II}$ ( $C_{min,v,\perp}$ ) <sup>1)</sup> | [mm] | 75 (1,5* $h_{ef}$ ) |           |           |            |
| Spacing                   | $S_{cr}$                                           | [mm] | 3* $h_{ef}$         |           |           |            |
| Minimum spacing           | $S_{min}$                                          | [mm] | 100                 |           |           |            |

<sup>1)</sup>  $C_{min,v,II}$  for shear loading parallel to the free edge;  $C_{min,v,\perp}$  for shear loading perpendicular the free edge

**Table C5: Group factor for anchor group in case of tension loading**

| Configuration                                       |                                                                                     | with $c \geq$ | with $s \geq$ |                      |     |     |
|-----------------------------------------------------|-------------------------------------------------------------------------------------|---------------|---------------|----------------------|-----|-----|
| II: anchors placed parallel to horizontal joint     |  | 125 (M8:120)  | 100           | $\alpha_{g,N,II}$    | [-] | 1,8 |
|                                                     |                                                                                     | 1,5* $h_{ef}$ | 3* $h_{ef}$   |                      |     | 2,0 |
| ⊥: anchors placed perpendicular to horizontal joint |  | 75            | 100           | $\alpha_{g,N,\perp}$ |     | 1,4 |
|                                                     |                                                                                     | 1,5* $h_{ef}$ | 3* $h_{ef}$   |                      |     | 2,0 |

**Table C6: Group factor for anchor group in case of shear loading parallel to free edge**

| Configuration                                       |                                                                                     | with $c \geq$ | with $s \geq$ |                      |     |     |
|-----------------------------------------------------|-------------------------------------------------------------------------------------|---------------|---------------|----------------------|-----|-----|
| II: anchors placed parallel to horizontal joint     |  | 75            | 100           | $\alpha_{g,V,II}$    | [-] | 1,2 |
|                                                     |                                                                                     | 1,5* $h_{ef}$ | 3* $h_{ef}$   |                      |     | 2,0 |
| ⊥: anchors placed perpendicular to horizontal joint |  | 1,5* $h_{ef}$ | 3* $h_{ef}$   | $\alpha_{g,V,\perp}$ |     | 2,0 |

**ESSVE Injection system ONE, ONE ICE for masonry**

**Performances Autoclaved Aerated Concrete - AAC6**

Description of the brick  
Installation parameters

**Annex C 4**

**Brick type: Autoclaved Aerated Concrete – AAC6**

**Table C7: Group factor for anchor group in case of shear loading perpendicular to free edge**

| Configuration                                       |  | with $c \geq$ | with $s \geq$ |                   |     |     |
|-----------------------------------------------------|--|---------------|---------------|-------------------|-----|-----|
| II: anchors placed parallel to horizontal joint     |  | 1,5*hef       | 3,0*hef       | $\alpha_{g,V,II}$ | [-] | 2,0 |
| I: anchors placed perpendicular to horizontal joint |  | 1,5*hef       | 3,0*hef       | $\alpha_{g,V,I}$  |     | 2,0 |

**Table C8: Characteristic values of resistance under tension and shear loads**

| Anchor size                                                        | Effective anchorage depth | Characteristic resistance  |           |            |                            |           |            |                           |
|--------------------------------------------------------------------|---------------------------|----------------------------|-----------|------------|----------------------------|-----------|------------|---------------------------|
|                                                                    |                           | Use category               |           |            |                            |           |            |                           |
|                                                                    |                           | d/d                        |           |            | w/w<br>w/d                 |           |            | d/d<br>w/d<br>w/w         |
|                                                                    |                           | 40°C/24°C                  | 80°C/50°C | 120°C/72°C | 40°C/24°C                  | 80°C/50°C | 120°C/72°C | For all temperature range |
|                                                                    | $h_{ef}$<br>[mm]          | $N_{Rk,b} = N_{Rk,p}^{1)}$ |           |            | $N_{Rk,b} = N_{Rk,p}^{1)}$ |           |            | $V_{Rk,b}^{2)3)}$         |
| <b>Compressive strength <math>f_b \geq 6 \text{ N/mm}^2</math></b> |                           |                            |           |            |                            |           |            |                           |
| M8                                                                 | 80                        | 2,5 (2,0)                  | 2,5 (1,5) | 2,0 (1,2)  | 2,5 (1,5)                  | 2,0 (1,5) | 1,5 (1,2)  | 6,0                       |
| M10/IG-M6                                                          | 90                        | 4,0 (2,5)                  | 3,0 (2,0) | 2,5 (1,5)  | 3,5 (2,5)                  | 3,0 (2,0) | 2,5 (1,5)  | 10,0                      |
| M12/IG-M8                                                          | 100                       | 5,0 (3,5)                  | 4,0 (3,0) | 3,0 (2,5)  | 4,5 (3,0)                  | 3,5 (2,5) | 3,0 (2,5)  | 10,0                      |
| M16/IG-M10                                                         | 100                       | 6,5 (4,5)                  | 5,5 (3,5) | 4,0 (3,0)  | 5,5 (4,0)                  | 5,0 (3,5) | 4,0 (3,0)  | 10,0                      |

- 1) Values are valid for  $c_{cr}$ , values in brackets are valid for single anchors with  $c_{min}$   
 2) For calculation of  $V_{Rk,c}$  see ETAG029, Annex C;  
 3) The values are valid for steel 5.6 or greater. For steel 4.6 and 4.8 multiply  $V_{Rk,b}$  by 0,8

**Table C9: Displacements**

| Anchor size | $h_{ef}$<br>[mm] | N<br>[kN] | $\delta_N / N$<br>[mm/kN] | $\delta_{N0}$<br>[mm] | $\delta_{N\infty}$<br>[mm] | V<br>[kN] | $\delta_{V0}$<br>[mm] | $\delta_{V\infty}$<br>[mm] |
|-------------|------------------|-----------|---------------------------|-----------------------|----------------------------|-----------|-----------------------|----------------------------|
| M8          | 80               | 0,9       | 0,18                      | 0,16                  | 0,32                       | 1,3       | 0,8                   | 1,20                       |
| M10/IG-M6   | 90               | 1,4       |                           | 0,26                  | 0,51                       | 1,8       | 1,2                   | 1,80                       |
| M12/IG-M8   | 100              | 1,8       | 0,08                      | 0,14                  | 0,29                       | 2,1       | 1,4                   | 2,10                       |
| M16/IG-M10  | 100              | 2,3       |                           | 0,19                  | 0,37                       | 2,3       | 1,5                   | 2,25                       |

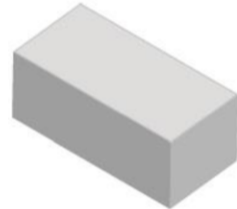
**ESSVE Injection system ONE, ONE ICE for masonry**

**Performances Autoclaved Aerated Concrete – AAC6**

Installation parameters (continue)

Characteristic values of resistance under tension and shear load / Displacements

**Annex C 5**



**Brick type: Calcium silicate solid brick KS-NF**

**Table C10: Description of the brick**

|                                                      |                                    |
|------------------------------------------------------|------------------------------------|
| Brick type                                           | Calcium silicate solid brick KS-NF |
| Bulk density $\rho$ [kg/dm <sup>3</sup> ]            | 2,0                                |
| Compressive strength $f_b \geq$ [N/mm <sup>2</sup> ] | 10, 20 or 27                       |
| Code                                                 | EN 771-2                           |
| Producer (country code)                              | e.g. Wemding (DE)                  |
| Brick dimensions [mm]                                | 240 x 115 x 71                     |
| Drilling method                                      | Hammer                             |

**Table C11: Installation parameter**

|                       |           |      |                    |
|-----------------------|-----------|------|--------------------|
| Anchor size           |           | [-]  | All sizes          |
| Edge distance         | $c_{cr}$  | [mm] | $1,5 \cdot h_{ef}$ |
| Minimum edge distance | $c_{min}$ | [mm] | 60                 |
| Spacing               | $s_{cr}$  | [mm] | $3 \cdot h_{ef}$   |
| Minimum spacing       | $s_{min}$ | [mm] | 120                |

**Table C12: Group factor for anchor group in case of tension loading**

| Configuration                                       |  | with $c \geq$      | with $s \geq$    |                      |     |     |
|-----------------------------------------------------|--|--------------------|------------------|----------------------|-----|-----|
| II: anchors placed parallel to horizontal joint     |  | 60                 | 120              | $\alpha_{g,N,II}$    | [-] | 1,0 |
|                                                     |  | 140                | 120              |                      |     | 1,5 |
|                                                     |  | $1,5 \cdot h_{ef}$ | $3 \cdot h_{ef}$ |                      |     | 2,0 |
| ⊥: anchors placed perpendicular to horizontal joint |  | 60                 | 120              | $\alpha_{g,N,\perp}$ | [-] | 0,5 |
|                                                     |  | $1,5 \cdot h_{ef}$ | 120              |                      |     | 1,0 |
|                                                     |  | $1,5 \cdot h_{ef}$ | $3 \cdot h_{ef}$ |                      |     | 2,0 |

**Table C13: Group factor for anchor group in case of shear loading parallel to free edge**

| Configuration                                       |  | with $c \geq$      | with $s \geq$    |                      |     |     |
|-----------------------------------------------------|--|--------------------|------------------|----------------------|-----|-----|
| II: anchors placed parallel to horizontal joint     |  | 60                 | 120              | $\alpha_{g,V,II}$    | [-] | 1,0 |
|                                                     |  | 115                | 120              |                      |     | 1,7 |
|                                                     |  | $1,5 \cdot h_{ef}$ | $3 \cdot h_{ef}$ |                      |     | 2,0 |
| ⊥: anchors placed perpendicular to horizontal joint |  | 60                 | 120              | $\alpha_{g,V,\perp}$ | [-] | 1,0 |
|                                                     |  | $1,5 \cdot h_{ef}$ | 120              |                      |     | 1,0 |
|                                                     |  | $1,5 \cdot h_{ef}$ | $3 \cdot h_{ef}$ |                      |     | 2,0 |

**Table C14: Group factor for anchor group in case of shear loading perpendicular to free edge**

| Configuration                                       |  | with $c \geq$      | with $s \geq$    |                      |     |     |
|-----------------------------------------------------|--|--------------------|------------------|----------------------|-----|-----|
| II: anchors placed parallel to horizontal joint     |  | 60                 | 120              | $\alpha_{g,V,II}$    | [-] | 1,0 |
|                                                     |  | $1,5 \cdot h_{ef}$ | $3 \cdot h_{ef}$ |                      |     | 2,0 |
| ⊥: anchors placed perpendicular to horizontal joint |  | 60                 | 120              | $\alpha_{g,V,\perp}$ | [-] | 1,0 |
|                                                     |  | $1,5 \cdot h_{ef}$ | $3 \cdot h_{ef}$ |                      |     | 2,0 |

**ESSVE Injection system ONE, ONE ICE for masonry**

**Performances calcium solid brick KS-NF**  
Installation parameters

**Annex C 6**

**Brick type: Calcium silicate solid brick KS-NF**

**Table C15: Characteristic values of resistance under tension and shear loads**

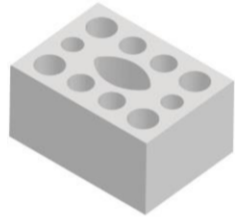
| Anchor size                                                                                                                                                                                                                                                                                                                                                                                   | Sleeve                     | Effective anchorage depth $h_{ef}$ [mm] | Characteristic resistance |                            |            |            |                   |                  |                           |
|-----------------------------------------------------------------------------------------------------------------------------------------------------------------------------------------------------------------------------------------------------------------------------------------------------------------------------------------------------------------------------------------------|----------------------------|-----------------------------------------|---------------------------|----------------------------|------------|------------|-------------------|------------------|---------------------------|
|                                                                                                                                                                                                                                                                                                                                                                                               |                            |                                         | Use category              |                            |            |            |                   |                  |                           |
|                                                                                                                                                                                                                                                                                                                                                                                               |                            |                                         | d/d                       |                            |            | w/d<br>w/w |                   |                  | d/d<br>w/d<br>w/w         |
|                                                                                                                                                                                                                                                                                                                                                                                               |                            |                                         | 40°C/24°C                 | 80°C/50°C                  | 120°C/72°C | 40°C/24°C  | 80°C/50°C         | 120°C/72°C       | For All temperature range |
| $h_{ef}$                                                                                                                                                                                                                                                                                                                                                                                      | $N_{Rk,b} = N_{Rk,p}^{1)}$ |                                         |                           | $N_{Rk,b} = N_{Rk,p}^{1)}$ |            |            | $V_{Rk,b}^{2)3)}$ |                  |                           |
| [mm]                                                                                                                                                                                                                                                                                                                                                                                          | [kN]                       |                                         |                           |                            |            |            |                   |                  |                           |
| <b>Compressive strength <math>f_b \geq 10 \text{ N/mm}^2</math></b>                                                                                                                                                                                                                                                                                                                           |                            |                                         |                           |                            |            |            |                   |                  |                           |
| M8                                                                                                                                                                                                                                                                                                                                                                                            | -                          | 80                                      | 4,5 (2,0)                 | 4,5 (2,0)                  | 3,0 (1,5)  | 3,5 (1,5)  | 3,5 (1,5)         | 2,5 (1,2)        | 2,5 (1,5)                 |
| M10 / IG-M6                                                                                                                                                                                                                                                                                                                                                                                   | -                          | 90                                      | 4,5 (2,0)                 | 4,5 (2,0)                  | 3,0 (1,5)  | 3,5 (1,5)  | 3,5 (1,5)         | 2,5 (1,2)        | 3,0 (2,0)                 |
| M12 / IG-M8                                                                                                                                                                                                                                                                                                                                                                                   | -                          | 100                                     | 4,5 (2,0)                 | 4,5 (2,0)                  | 3,0 (1,5)  | 3,5 (1,5)  | 3,5 (1,5)         | 2,5 (1,2)        | 2,5 (1,5)                 |
| M16 / IG-M10                                                                                                                                                                                                                                                                                                                                                                                  | -                          | 100                                     | 3,5 (1,5)                 | 3,5 (1,5)                  | 2,5 (1,2)  | 3,0 (1,5)  | 3,5 (1,5)         | 2,0 (0,9)        | 2,5 (1,5)                 |
| M8                                                                                                                                                                                                                                                                                                                                                                                            | 12x80                      | 80                                      | 3,5 (1,5)                 | 3,5 (1,5)                  | 2,5 (1,2)  | 3,5 (1,5)  | 3,0 (1,5)         | 2,5 (1,2)        | 2,5 (1,5)                 |
| M8 / M10 / IG-M6                                                                                                                                                                                                                                                                                                                                                                              | 16x85                      | 85                                      | 3,5 (1,5)                 | 3,0 (1,5)                  | 2,0 (0,9)  | 3,5 (1,5)  | 3,0 (1,5)         | 2,5 (1,2)        | 2,5 (1,5)                 |
|                                                                                                                                                                                                                                                                                                                                                                                               | 16x130                     | 130                                     | 3,5 (1,5)                 | 3,0 (1,5)                  | 2,0 (0,9)  | 3,5 (1,5)  | 3,0 (1,5)         | 2,5 (1,2)        | 2,5 (1,5)                 |
| M12 / M16 / IG-M8 / IG-M10                                                                                                                                                                                                                                                                                                                                                                    | 20x85                      | 85                                      | 3,0 (1,5)                 | 2,5 (1,2)                  | 2,0 (0,9)  | 3,0 (1,5)  | 2,5 (1,2)         | 2,0 (0,9)        | 2,5 (1,5)                 |
|                                                                                                                                                                                                                                                                                                                                                                                               | 20x130                     | 130                                     | 3,0 (1,5)                 | 2,5 (1,2)                  | 2,0 (0,9)  | 3,0 (1,5)  | 2,5 (1,2)         | 2,0 (0,9)        | 2,5 (1,5)                 |
|                                                                                                                                                                                                                                                                                                                                                                                               | 20x200                     | 200                                     | 3,0 (1,5)                 | 2,5 (1,2)                  | 2,0 (0,9)  | 3,0 (1,5)  | 2,5 (1,2)         | 2,0 (0,9)        | 2,5 (1,5)                 |
| <b>Compressive strength <math>f_b \geq 20 \text{ N/mm}^2</math></b>                                                                                                                                                                                                                                                                                                                           |                            |                                         |                           |                            |            |            |                   |                  |                           |
| M8                                                                                                                                                                                                                                                                                                                                                                                            | -                          | 80                                      | 6,0 (3,0)                 | 5,5 (2,5)                  | 4,0 (2,0)  | 5,0 (2,5)  | 5,0 (2,5)         | 3,5 (1,5)        | 4,0 (2,5)                 |
| M10 / IG-M6                                                                                                                                                                                                                                                                                                                                                                                   | -                          | 90                                      | 6,0 (3,0)                 | 5,5 (2,5)                  | 4,0 (2,0)  | 5,0 (2,5)  | 5,0 (2,5)         | 3,5 (1,5)        | 4,5 (2,5)                 |
| M12 / IG-M8                                                                                                                                                                                                                                                                                                                                                                                   | -                          | 100                                     | 6,0 (3,0)                 | 5,5 (2,5)                  | 4,0 (2,0)  | 5,0 (2,5)  | 5,0 (2,5)         | 3,5 (1,5)        | 4,0 (2,5)                 |
| M16 / IG-M10                                                                                                                                                                                                                                                                                                                                                                                  | -                          | 100                                     | 5,0 (2,5)                 | 5,0 (2,5)                  | 3,5 (1,5)  | 5,0 (2,5)  | 5,0 (2,5)         | 3,5 (1,5)        | 4,0 (2,5)                 |
| M8                                                                                                                                                                                                                                                                                                                                                                                            | 12x80                      | 80                                      | 5,5 (2,5)                 | 5,0 (2,5)                  | 3,5 (1,5)  | 4,5 (2,0)  | 4,5 (2,0)         | 3,0 (1,5)        | 4,0 (2,5)                 |
| M8 / M10 / IG-M6                                                                                                                                                                                                                                                                                                                                                                              | 16x85                      | 85                                      | 5,0 (2,5)                 | 4,5 (2,0)                  | 3,5 (1,5)  | 5,0 (2,5)  | 4,5 (2,0)         | 3,5 (1,5)        | 4,0 (2,5)                 |
|                                                                                                                                                                                                                                                                                                                                                                                               | 16x130                     | 130                                     | 5,0 (2,5)                 | 4,5 (2,0)                  | 3,5 (1,5)  | 5,0 (2,5)  | 4,5 (2,0)         | 3,5 (1,5)        | 4,0 (2,5)                 |
| M12 / M16 / IG-M8 / IG-M10                                                                                                                                                                                                                                                                                                                                                                    | 20x85                      | 85                                      | 4,0 (2,0)                 | 4,0 (2,0)                  | 3,0 (1,5)  | 4,0 (2,0)  | 4,0 (2,0)         | 3,0 (1,5)        | 4,0 (2,5)                 |
|                                                                                                                                                                                                                                                                                                                                                                                               | 20x130                     | 130                                     | 4,0 (2,0)                 | 4,0 (2,0)                  | 3,0 (1,5)  | 4,0 (2,0)  | 4,0 (2,0)         | 3,0 (1,5)        | 4,0 (2,5)                 |
|                                                                                                                                                                                                                                                                                                                                                                                               | 20x200                     | 200                                     | 4,0 (2,0)                 | 4,0 (2,0)                  | 3,0 (1,5)  | 4,0 (2,0)  | 4,0 (2,0)         | 3,0 (1,5)        | 4,0 (2,5)                 |
| <sup>1)</sup> Values are valid for $c_{cr}$ , values in brackets are valid for single anchors with $c_{min}$<br><sup>2)</sup> For $c_{cr}$ calculation of $V_{Rk,c}$ see Technical Report TR 054; values in brackets $V_{Rk,b} = V_{Rk,c}$ for single anchors with $c_{min}$<br><sup>3)</sup> The values are valid for steel 5.6 or greater. For steel 4.6 and 4.8 multiply $V_{Rk,b}$ by 0,8 |                            |                                         |                           |                            |            |            |                   |                  |                           |
| <b>ESSVE Injection system ONE, ONE ICE for masonry</b>                                                                                                                                                                                                                                                                                                                                        |                            |                                         |                           |                            |            |            |                   | <b>Annex C 7</b> |                           |
| <b>Performances calcium solid brick KS-NF</b>                                                                                                                                                                                                                                                                                                                                                 |                            |                                         |                           |                            |            |            |                   |                  |                           |
| Characteristic values of resistance under tension and shear load                                                                                                                                                                                                                                                                                                                              |                            |                                         |                           |                            |            |            |                   |                  |                           |

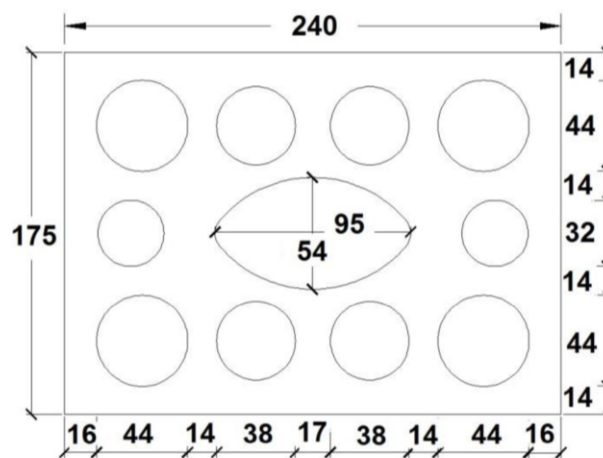


| <b>Brick type: Calcium silicate solid brick KS-NF</b>                                                                                                                                                                                                                                                                                                                                         |        |                                         |                            |                |               |                            |                  |               |                           |
|-----------------------------------------------------------------------------------------------------------------------------------------------------------------------------------------------------------------------------------------------------------------------------------------------------------------------------------------------------------------------------------------------|--------|-----------------------------------------|----------------------------|----------------|---------------|----------------------------|------------------|---------------|---------------------------|
| <b>Table C16: Characteristic values of resistance under tension and shear loads (continue)</b>                                                                                                                                                                                                                                                                                                |        |                                         |                            |                |               |                            |                  |               |                           |
| Anchor size                                                                                                                                                                                                                                                                                                                                                                                   | Sleeve | Effective anchorage depth $h_{ef}$ [mm] | Characteristic resistance  |                |               |                            |                  |               |                           |
|                                                                                                                                                                                                                                                                                                                                                                                               |        |                                         | Use category               |                |               |                            |                  |               |                           |
|                                                                                                                                                                                                                                                                                                                                                                                               |        |                                         | d/d                        |                |               | w/d<br>w/w                 |                  |               | d/d<br>w/d<br>w/w         |
|                                                                                                                                                                                                                                                                                                                                                                                               |        |                                         | 40°C/24°C                  | 80°C/50°C      | 120°C/72°C    | 40°C/24°C                  | 80°C/50°C        | 120°C/72°C    | For All temperature range |
|                                                                                                                                                                                                                                                                                                                                                                                               |        | $h_{ef}$                                | $N_{Rk,b} = N_{Rk,p}^{1)}$ |                |               | $N_{Rk,b} = N_{Rk,p}^{1)}$ |                  |               | $V_{Rk,b}^{2,3)}$         |
|                                                                                                                                                                                                                                                                                                                                                                                               |        | [mm]                                    | [kN]                       |                |               |                            |                  |               |                           |
| <b>Compressive strength <math>f_b \geq 27 \text{ N/mm}^2</math></b>                                                                                                                                                                                                                                                                                                                           |        |                                         |                            |                |               |                            |                  |               |                           |
| M8                                                                                                                                                                                                                                                                                                                                                                                            | -      | 80                                      | 7,0 (3,5)                  | 6,5 (3,0)      | 5,0 (2,5)     | 6,0 (3,0)                  | 5,5 (2,5)        | 4,0 (2,0)     | 4,5 (2,5)                 |
| M10 / IG-M6                                                                                                                                                                                                                                                                                                                                                                                   | -      | 90                                      | 7,0 (3,5)                  | 6,5 (3,0)      | 5,0 (2,5)     | 6,0 (3,0)                  | 5,5 (2,5)        | 4,0 (2,0)     | 5,5 (3,0)                 |
| M12 / IG-M8                                                                                                                                                                                                                                                                                                                                                                                   | -      | 100                                     | 7,0 (3,5)                  | 6,5 (3,0)      | 5,0 (2,5)     | 6,0 (3,0)                  | 5,5 (2,5)        | 4,0 (2,0)     | 4,5 (2,5)                 |
| M16 / IG-M10                                                                                                                                                                                                                                                                                                                                                                                  | -      | 100                                     | 6,0 (3,0)                  | 5,5 (2,5)      | 4,5 (2,0)     | 6,0 (3,0)                  | 5,5 (2,5)        | 4,0 (2,0)     | 4,5 (2,5)                 |
| M8                                                                                                                                                                                                                                                                                                                                                                                            | 12x80  | 80                                      | 6,5 (3,0)                  | 6,0 (3,0)      | 4,5 (2,0)     | 5,5 (2,5)                  | 5,0 (2,5)        | 3,5 (1,5)     | 4,5 (2,5)                 |
| M8 / M10 / IG-M6                                                                                                                                                                                                                                                                                                                                                                              | 16x85  | 85                                      | 5,5 (2,5)                  | 5,0 (2,5)      | 4,0 (2,0)     | 5,5 (2,5)                  | 5,0 (2,5)        | 4,0 (2,0)     | 4,5 (2,5)                 |
|                                                                                                                                                                                                                                                                                                                                                                                               | 16x130 | 130                                     | 5,5 (2,5)                  | 5,0 (2,5)      | 4,0 (2,0)     | 5,5 (2,5)                  | 5,0 (2,5)        | 4,0 (2,0)     | 4,5 (2,5)                 |
| M12 / M16 / IG-M8 / IG-M10                                                                                                                                                                                                                                                                                                                                                                    | 20x85  | 85                                      | 5,0 (2,5)                  | 4,5 (2,0)      | 3,5 (1,5)     | 5,0 (2,5)                  | 4,5 (2,0)        | 3,5 (1,5)     | 4,5 (2,5)                 |
|                                                                                                                                                                                                                                                                                                                                                                                               | 20x130 | 130                                     | 5,0 (2,5)                  | 4,5 (2,0)      | 3,5 (1,5)     | 5,0 (2,5)                  | 4,5 (2,0)        | 3,5 (1,5)     | 4,5 (2,5)                 |
|                                                                                                                                                                                                                                                                                                                                                                                               | 20x200 | 200                                     | 5,0 (2,5)                  | 4,5 (2,0)      | 3,5 (1,5)     | 5,0 (2,5)                  | 4,5 (2,0)        | 3,5 (1,5)     | 4,5 (2,5)                 |
| <sup>1)</sup> Values are valid for $c_{cr}$ , values in brackets are valid for single anchors with $c_{min}$<br><sup>2)</sup> For $c_{cr}$ calculation of $V_{Rk,c}$ see Technical Report TR 054; values in brackets $V_{Rk,b} = V_{Rk,c}$ for single anchors with $c_{min}$<br><sup>3)</sup> The values are valid for steel 5.6 or greater. For steel 4.6 and 4.8 multiply $V_{Rk,b}$ by 0,8 |        |                                         |                            |                |               |                            |                  |               |                           |
| <b>Table C17: Displacements</b>                                                                                                                                                                                                                                                                                                                                                               |        |                                         |                            |                |               |                            |                  |               |                           |
| Anchor size                                                                                                                                                                                                                                                                                                                                                                                   | Sleeve | Effective anchorage depth $h_{ef}$      | N                          | $\delta_N / N$ | $\delta_{N0}$ | $\delta_{N\infty}$         | V                | $\delta_{V0}$ | $\delta_{V\infty}$        |
|                                                                                                                                                                                                                                                                                                                                                                                               |        |                                         |                            |                |               |                            |                  |               |                           |
| M8                                                                                                                                                                                                                                                                                                                                                                                            | -      | 80                                      | 2,0                        | 0,15           | 0,30          | 0,60                       | 1,7              | 0,90          | 1,35                      |
| M10 / IG-M6                                                                                                                                                                                                                                                                                                                                                                                   | -      | 90                                      |                            |                |               |                            |                  |               |                           |
| M12 / IG-M8                                                                                                                                                                                                                                                                                                                                                                                   | -      | 100                                     |                            |                |               |                            |                  |               |                           |
| M16 / IG-M10                                                                                                                                                                                                                                                                                                                                                                                  | -      | 100                                     | 1,7                        |                | 0,26          | 0,51                       |                  |               |                           |
| M8                                                                                                                                                                                                                                                                                                                                                                                            | 12x80  | 80                                      | 1,4                        |                | 0,21          | 0,43                       | 1,7              | 0,90          | 1,35                      |
| M8 / M10 / IG-M6                                                                                                                                                                                                                                                                                                                                                                              | 16x85  | 85                                      |                            |                |               |                            |                  |               |                           |
|                                                                                                                                                                                                                                                                                                                                                                                               |        | 16x130                                  | 130                        |                |               |                            |                  |               |                           |
| M12 / M16 / IG-M8 / IG-M10                                                                                                                                                                                                                                                                                                                                                                    | 20x85  | 85                                      | 1,3                        |                | 0,19          | 0,39                       |                  |               |                           |
|                                                                                                                                                                                                                                                                                                                                                                                               | 20x130 | 130                                     |                            |                |               |                            |                  |               |                           |
|                                                                                                                                                                                                                                                                                                                                                                                               | 20x200 | 200                                     |                            |                |               |                            |                  |               |                           |
| <b>ESSVE Injection system ONE, ONE ICE for masonry</b>                                                                                                                                                                                                                                                                                                                                        |        |                                         |                            |                |               |                            | <b>Annex C 8</b> |               |                           |
| <b>Performances calcium solid brick KS-NF</b>                                                                                                                                                                                                                                                                                                                                                 |        |                                         |                            |                |               |                            |                  |               |                           |
| Characteristic values of resistance under tension and shear load (continue)<br>Displacements                                                                                                                                                                                                                                                                                                  |        |                                         |                            |                |               |                            |                  |               |                           |

**Brick type: Calcium silicate hollow brick KS L-3DF**

**Table C18: Description of the brick**

|                                                      |                                          |                                                                                     |
|------------------------------------------------------|------------------------------------------|-------------------------------------------------------------------------------------|
| Brick type                                           | Calcium silicate hollow brick<br>KSL-3DF |  |
| Bulk density $\rho$ [kg/dm <sup>3</sup> ]            | 1,4                                      |                                                                                     |
| Compressive strength $f_b \geq$ [N/mm <sup>2</sup> ] | 8, 12 or 14                              |                                                                                     |
| Code                                                 | EN 771-2                                 |                                                                                     |
| Producer (country code)                              | e.g. Wemding (DE)                        |                                                                                     |
| Brick dimensions [mm]                                | 240 x 175 x 113                          |                                                                                     |
| Drilling method                                      | Rotary                                   |                                                                                     |

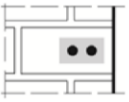
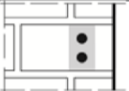


**Table C19: Installation parameters**

|                       |                |      |                         |
|-----------------------|----------------|------|-------------------------|
| Anchor size           |                | [-]  | All sizes               |
| Edge distance         | $C_{cr}$       | [mm] | 100 (120) <sup>1)</sup> |
| Minimum edge distance | $C_{min}$      | [mm] | 60                      |
| Spacing               | $S_{cr,II}$    | [mm] | 240                     |
|                       | $S_{cr,\perp}$ | [mm] | 120                     |
| Minimum spacing       | $S_{min}$      | [mm] | 120                     |

<sup>1)</sup> Value in brackets for SH20x85; SH20x130 and SH20x200

**Table C20: Group factor for anchor group in case of tension loading**

| Configuration                                       |                                                                                     | with $c \geq$ | with $s \geq$ |                      |     |     |
|-----------------------------------------------------|-------------------------------------------------------------------------------------|---------------|---------------|----------------------|-----|-----|
| II: anchors placed parallel to horizontal joint     |  | 60            | 120           | $\alpha_{g,N,II}$    | [-] | 1,5 |
|                                                     |                                                                                     | $C_{cr}$      | 240           |                      |     | 2,0 |
|                                                     |                                                                                     | 160           | 120           |                      |     | 2,0 |
| ⊥: anchors placed perpendicular to horizontal joint |  | 60            | 120           | $\alpha_{g,N,\perp}$ | [-] | 1,0 |
|                                                     |                                                                                     | $C_{cr}$      | 120           |                      |     | 2,0 |

**ESSVE Injection system ONE, ONE ICE for masonry**

**Performances calcium hollow brick KS L-3DF**

Description of the brick  
Installation parameters

**Annex C 9**

**Brick type: Calcium silicate hollow brick KS L-3DF**

**Table C21: Group factor for anchor group in case of shear loading parallel to free edge**

| Configuration                                       |  | with $c \geq$ | with $s \geq$ |                      |     |     |
|-----------------------------------------------------|--|---------------|---------------|----------------------|-----|-----|
| II: anchors placed parallel to horizontal joint     |  | 60            | 120           | $\alpha_{g,V,II}$    | [-] | 1,0 |
|                                                     |  | 160           | 120           |                      |     | 1,6 |
|                                                     |  | $c_{Cr}$      | 240           |                      |     | 2,0 |
| ⊥: anchors placed perpendicular to horizontal joint |  | 60            | 120           | $\alpha_{g,V,\perp}$ | [-] | 1,0 |
|                                                     |  | $c_{Cr}$      | 120           |                      |     | 2,0 |

**Table C22: Group factor for anchor group in case of shear loading perpendicular to free edge**

| Configuration                                   |     | with $c \geq$                                       | with $s \geq$ |                   |     |     |
|-------------------------------------------------|-----|-----------------------------------------------------|---------------|-------------------|-----|-----|
| II: anchors placed parallel to horizontal joint |     | 60                                                  | 120           | $\alpha_{g,V,II}$ | [-] | 1,0 |
|                                                 |     | $c_{Cr}$                                            | 240           |                   |     | 2,0 |
|                                                 |     | ⊥: anchors placed perpendicular to horizontal joint |               |                   |     | 60  |
| $c_{Cr}$                                        | 120 |                                                     |               | 2,0               |     |     |

**Table C23: Characteristic values of resistance under tension and shear loads**

| Anchor size                                                         | Sleeve | Effective anchorage depth | Characteristic resistance  |           |            |                            |           |            |                           |
|---------------------------------------------------------------------|--------|---------------------------|----------------------------|-----------|------------|----------------------------|-----------|------------|---------------------------|
|                                                                     |        |                           | Use category               |           |            |                            |           |            |                           |
|                                                                     |        |                           | d/d                        |           |            | w/d; w/w                   |           |            | d/d; w/d; w/w             |
|                                                                     |        |                           | 40°C/24°C                  | 80°C/50°C | 120°C/72°C | 40°C/24°C                  | 80°C/50°C | 120°C/72°C | For all temperature range |
|                                                                     |        | $h_{ef}$                  | $N_{RK,b} = N_{RK,p}^{1)}$ |           |            | $N_{RK,b} = N_{RK,p}^{1)}$ |           |            | $V_{RK,b}^{4)}$           |
|                                                                     |        | [mm]                      | [kN]                       |           |            |                            |           |            |                           |
| <b>Compressive strength <math>f_b \geq 8 \text{ N/mm}^2</math></b>  |        |                           |                            |           |            |                            |           |            |                           |
| M8                                                                  | 12x80  | 80                        | 1,5                        | 1,5       | 1,2        | 1,5                        | 1,2       | 0,9        | $2,5^{2)}$ ( $0,9^{3)}$   |
| M8 / M10 / IG-M6                                                    | 16x85  | 85                        | 1,5                        | 1,5       | 1,2        | 1,5                        | 1,5       | 1,2        | $4,0^{2)}$ ( $1,5^{3)}$   |
|                                                                     | 16x130 | 130                       | 1,5                        | 1,5       | 1,2        | 1,5                        | 1,5       | 1,2        | $4,0^{2)}$ ( $1,5^{3)}$   |
| M12 / M16 / IG-M8 / IG-M10                                          | 20x85  | 85                        | 4,5                        | 4,0       | 3,0        | 4,5                        | 4,0       | 3,0        | $4,0^{2)}$ ( $1,5^{3)}$   |
|                                                                     | 20x130 | 130                       | 4,5                        | 4,0       | 3,0        | 4,5                        | 4,0       | 3,0        | $4,0^{2)}$ ( $1,5^{3)}$   |
|                                                                     | 20x200 | 200                       | 4,5                        | 4,0       | 3,0        | 4,5                        | 4,0       | 3,0        | $4,0^{2)}$ ( $1,5^{3)}$   |
| <b>Compressive strength <math>f_b \geq 12 \text{ N/mm}^2</math></b> |        |                           |                            |           |            |                            |           |            |                           |
| M8                                                                  | 12x80  | 80                        | 2,0                        | 2,0       | 1,5        | 2,0                        | 1,5       | 1,2        | $3,0^{2)}$ ( $1,2^{3)}$   |
| M8 / M10 / IG-M6                                                    | 16x85  | 85                        | 2,0                        | 2,0       | 1,5        | 2,0                        | 2,0       | 1,5        | $4,5^{2)}$ ( $1,5^{3)}$   |
|                                                                     | 16x130 | 130                       | 2,5                        | 2,5       | 1,5        | 2,5                        | 2,5       | 1,5        | $4,5^{2)}$ ( $1,5^{3)}$   |
| M12 / M16 / IG-M8 / IG-M10                                          | 20x85  | 85                        | 6,0                        | 5,5       | 4,0        | 6,0                        | 5,5       | 4,0        | $4,5^{2)}$ ( $1,5^{3)}$   |
|                                                                     | 20x130 | 130                       | 6,0                        | 5,5       | 4,0        | 6,0                        | 5,5       | 4,0        | $4,5^{2)}$ ( $1,5^{3)}$   |
|                                                                     | 20x200 | 200                       | 6,0                        | 5,5       | 4,0        | 6,0                        | 5,5       | 4,0        | $4,5^{2)}$ ( $1,5^{3)}$   |

<sup>1)</sup> Values are valid for  $c_{Cr}$  and  $c_{min}$

<sup>2)</sup>  $V_{RK,c,II} = V_{RK,b}$  valid for shear load parallel to free edge

<sup>3)</sup>  $V_{RK,c,\perp} = V_{RK,b}$  (values in brackets) valid for shear load in direction to free edge

<sup>4)</sup> The values are valid for steel 5.6 or greater. For steel 4.6 and 4.8 multiply  $V_{RK,b}$  by 0,8

|                                                                                                        |                   |
|--------------------------------------------------------------------------------------------------------|-------------------|
| <b>ESSVE Injection system ONE, ONE ICE for masonry</b>                                                 | <b>Annex C 10</b> |
| <b>Performances calcium hollow brick KS L-3DF</b>                                                      |                   |
| Installation parameters (continue)<br>Characteristic values of resistance under tension and shear load |                   |

**Brick type: Calcium silicate hollow brick KS L-3DF**

**Table C24: Characteristic values of resistance under tension and shear loads (continue)**

| Anchor size                                                         | Sleeve | Effective anchorage depth | Characteristic resistance  |           |            |                            |           |            |                           |
|---------------------------------------------------------------------|--------|---------------------------|----------------------------|-----------|------------|----------------------------|-----------|------------|---------------------------|
|                                                                     |        |                           | Use category               |           |            |                            |           |            |                           |
|                                                                     |        |                           | d/d                        |           |            | w/d<br>w/w                 |           |            | d/d; w/d;<br>w/w          |
|                                                                     |        |                           | 40°C/24°C                  | 80°C/50°C | 120°C/72°C | 40°C/24°C                  | 80°C/50°C | 120°C/72°C | For all temperature range |
|                                                                     |        | $h_{ef}$                  | $N_{Rk,b} = N_{Rk,p}^{1)}$ |           |            | $N_{Rk,b} = N_{Rk,p}^{1)}$ |           |            | $V_{Rk,b}^{4)}$           |
|                                                                     |        | [mm]                      | [kN]                       |           |            |                            |           |            |                           |
| <b>Compressive strength <math>f_b \geq 14 \text{ N/mm}^2</math></b> |        |                           |                            |           |            |                            |           |            |                           |
| M8                                                                  | 12x80  | 80                        | 2,5                        | 2,5       | 1,5        | 2,0                        | 2,0       | 1,5        | $3,5^{2)}$ ( $1,5^{3)}$   |
| M8 / M10 / IG-M6                                                    | 16x85  | 85                        | 2,5                        | 2,5       | 1,5        | 2,5                        | 2,5       | 1,5        | $6,0^{2)}$ ( $2,0^{3)}$   |
|                                                                     | 16x130 | 130                       | 2,5                        | 2,5       | 2,0        | 2,5                        | 2,5       | 2,0        | $6,0^{2)}$ ( $2,0^{3)}$   |
| M12 / M16 / IG-M8 / IG-M10                                          | 20x85  | 85                        | 6,5                        | 6,0       | 4,5        | 6,5                        | 6,0       | 4,5        | $6,0^{2)}$ ( $2,0^{3)}$   |
|                                                                     | 20x130 | 130                       | 6,5                        | 6,0       | 4,5        | 6,5                        | 6,0       | 4,5        | $6,0^{2)}$ ( $2,0^{3)}$   |
|                                                                     | 20x200 | 200                       | 6,5                        | 6,0       | 4,5        | 6,5                        | 6,0       | 4,5        | $6,0^{2)}$ ( $2,0^{3)}$   |

1) Values are valid for  $C_{cr}$  and  $C_{min}$

2)  $V_{Rk,c,II} = V_{Rk,b}$  valid for shear load parallel to free edge

3)  $V_{Rk,c,I} = V_{Rk,b}$  (values in brackets) valid for shear load in direction to free edge

4) The values are valid for steel 5.6 or greater. For steel 4.6 and 4.8 multiply  $V_{Rk,b}$  by 0,8

**Table C25: Displacements**

| Anchor size                | Sleeve | Effective anchorage depth $h_{ef}$ | N    | $\delta_N / N$ | $\delta_{N0}$ | $\delta_{N\infty}$ | V    | $\delta_{V0}$ | $\delta_{V\infty}$ |
|----------------------------|--------|------------------------------------|------|----------------|---------------|--------------------|------|---------------|--------------------|
|                            |        |                                    | [kN] | [mm/kN]        | [mm]          | [mm]               | [kN] | [mm]          | [mm]               |
| M8                         | 12x80  | 80                                 | 0,71 | 0,90           | 0,64          | 1,29               | 1,0  | 1,0           | 1,50               |
| M8 / M10 / IG-M6           | 16x85  | 85                                 |      |                |               |                    | 1,86 | 1,67          | 3,34               |
|                            |        | 16x130                             | 130  |                |               |                    |      |               |                    |
| M12 / M16 / IG-M8 / IG-M10 | 20x85  | 85                                 |      |                |               |                    |      |               |                    |
|                            | 20x130 | 130                                |      |                |               |                    |      |               |                    |
|                            | 20x200 | 200                                |      |                |               |                    |      |               |                    |

**ESSVE Injection system ONE, ONE ICE for masonry**

**Performances calcium hollow brick KS L-3DF**


Characteristic values of resistance under tension and shear load (continue)

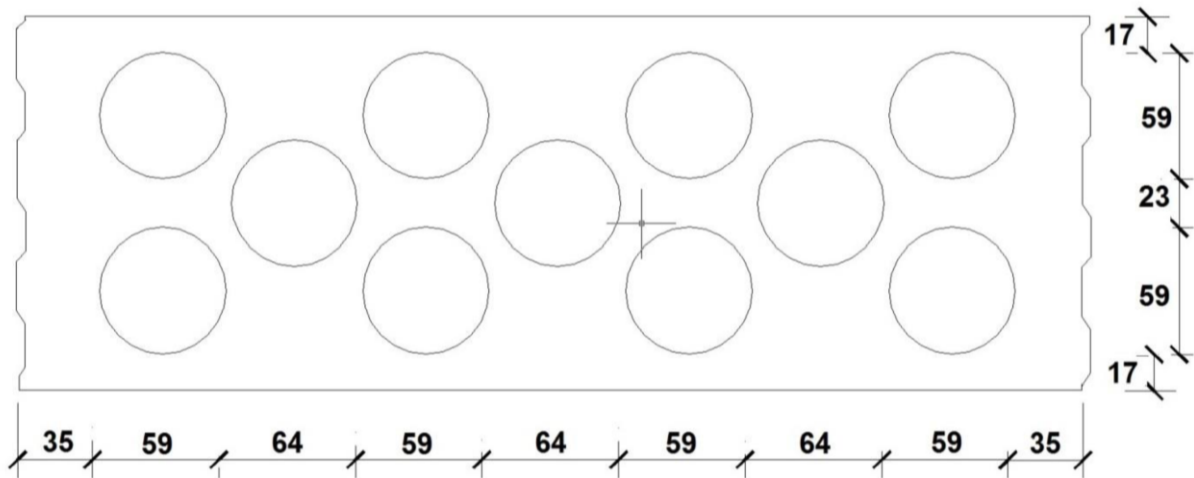
Displacements

**Annex C 11**

**Brick type: Calcium silicate hollow brick KS L-12DF**

**Table C26: Description of the brick**

|                                                      |                                        |                                                                                     |
|------------------------------------------------------|----------------------------------------|-------------------------------------------------------------------------------------|
| Brick type                                           | Calcium silicate hollow brick KSL-12DF |  |
| Bulk density $\rho$ [kg/dm <sup>3</sup> ]            | 1,4                                    |                                                                                     |
| Compressive strength $f_b \geq$ [N/mm <sup>2</sup> ] | 10, 12 or 16                           |                                                                                     |
| Code                                                 | EN 771-2                               |                                                                                     |
| Producer (country code)                              | e.g. Wemding (DE)                      |                                                                                     |
| Brick dimensions [mm]                                | 498 x 175 x 238                        |                                                                                     |
| Drilling method                                      | Rotary                                 |                                                                                     |




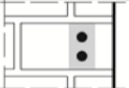
**Table C27: Installation parameters**

|                       |                         |      |                         |
|-----------------------|-------------------------|------|-------------------------|
| Anchor size           |                         | [-]  | All sizes               |
| Edge distance         | $C_{cr}$                | [mm] | 100 (120) <sup>1)</sup> |
| Minimum edge distance | $C_{min}$ <sup>2)</sup> | [mm] | 100 (120) <sup>1)</sup> |
| Spacing               | $S_{cr,II}$             | [mm] | 498                     |
|                       | $S_{cr,I}$              | [mm] | 238                     |
| Minimum spacing       | $S_{min}$               | [mm] | 120                     |

<sup>1)</sup> Value in brackets for SH20x85 and SH20x130

<sup>2)</sup> For  $V_{Rk,c}$ :  $C_{min}$  according to Technical Report TR 054

**Table C28: Group factor for anchor group in case of tension loading**

| Configuration                                       |                                                                                     | with $c \geq$ | with $s \geq$ | $\alpha_{g,N,II}$ | [-] |     |
|-----------------------------------------------------|-------------------------------------------------------------------------------------|---------------|---------------|-------------------|-----|-----|
| II: anchors placed parallel to horizontal joint     |  | 100           | 120           |                   |     |     |
|                                                     |                                                                                     | $C_{cr}$      | 498           | 2,0               |     |     |
| ⊥: anchors placed perpendicular to horizontal joint |  | 100           | 120           | $\alpha_{g,N,I}$  | 1,0 |     |
|                                                     |                                                                                     | $C_{cr}$      | 238           |                   |     | 2,0 |

**ESSVE Injection system ONE, ONE ICE for masonry**

**Performances Calcium hollow brick KS L-12DF**

Description of the brick  
Installation parameters

**Annex C 12**

**Brick type: Calcium silicate hollow brick KS L-12DF**

**Table C29: Group factor for anchor group in case of shear loading parallel to free edge**

| Configuration                                       |  | with $c \geq$ | with $s \geq$ |                   |     |     |
|-----------------------------------------------------|--|---------------|---------------|-------------------|-----|-----|
| II: anchors placed parallel to horizontal joint     |  | $C_{Cr}$      | 498           | $\alpha_{g,V,II}$ | [-] | 2,0 |
| I: anchors placed perpendicular to horizontal joint |  | $C_{Cr}$      | 238           | $\alpha_{g,V,I}$  |     | 2,0 |

**Table C30: Group factor for anchor group in case of shear loading perpendicular to free edge**

| Configuration                                       |  | with $c \geq$ | with $s \geq$ |                   |     |     |
|-----------------------------------------------------|--|---------------|---------------|-------------------|-----|-----|
| II: anchors placed parallel to horizontal joint     |  | $C_{Cr}$      | 498           | $\alpha_{g,V,II}$ | [-] | 2,0 |
| I: anchors placed perpendicular to horizontal joint |  | $C_{Cr}$      | 238           | $\alpha_{g,V,I}$  |     | 2,0 |

**Table C31: Characteristic values of resistance under tension and shear loads**

| Anchor size                                                         | Sleeve | Effective anchorage depth | Characteristic resistance  |           |            |                            |           |            |                           |
|---------------------------------------------------------------------|--------|---------------------------|----------------------------|-----------|------------|----------------------------|-----------|------------|---------------------------|
|                                                                     |        |                           | Use category               |           |            |                            |           |            |                           |
|                                                                     |        |                           | d/d                        |           |            | w/d<br>w/w                 |           |            | d/d<br>w/d<br>w/w         |
|                                                                     |        |                           | 40°C/24°C                  | 80°C/50°C | 120°C/72°C | 40°C/24°C                  | 80°C/50°C | 120°C/72°C | For all temperature range |
|                                                                     |        | $h_{ef}$                  | $N_{RK,b} = N_{RK,p}^{1)}$ |           |            | $N_{RK,b} = N_{RK,p}^{1)}$ |           |            | $V_{RK,b}^{2)3)}$         |
|                                                                     |        | [mm]                      | [kN]                       |           |            |                            |           |            |                           |
| <b>Compressive strength <math>f_b \geq 10 \text{ N/mm}^2</math></b> |        |                           |                            |           |            |                            |           |            |                           |
| M8                                                                  | 12x80  | 80                        | 0,6                        | 0,6       | 0,4        | 0,5                        | 0,5       | 0,4        | 2,5                       |
| M8 / M10 / IG-M6                                                    | 16x85  | 85                        | 0,6                        | 0,6       | 0,4        | 0,6                        | 0,6       | 0,4        | 5,5                       |
|                                                                     | 16x130 | 130                       | 2,5                        | 2,5       | 2,0        | 2,5                        | 2,5       | 2,0        | 5,5                       |
| M12 / M16 / IG-M8 / IG-M10                                          | 20x85  | 85                        | 1,5                        | 1,5       | 0,9        | 1,5                        | 1,5       | 0,9        | 5,5                       |
|                                                                     | 20x130 | 130                       | 2,5                        | 2,5       | 2,0        | 2,5                        | 2,5       | 2,0        | 5,5                       |
| <b>Compressive strength <math>f_b \geq 12 \text{ N/mm}^2</math></b> |        |                           |                            |           |            |                            |           |            |                           |
| M8                                                                  | 12x80  | 80                        | 0,75                       | 0,6       | 0,5        | 0,6                        | 0,6       | 0,4        | 3,0                       |
| M8 / M10 / IG-M6                                                    | 16x85  | 85                        | 0,75                       | 0,6       | 0,5        | 0,75                       | 0,6       | 0,5        | 6,5                       |
|                                                                     | 16x130 | 130                       | 3,0                        | 3,0       | 2,0        | 3,0                        | 3,0       | 2,0        | 6,5                       |
| M12 / M16 / IG-M8 / IG-M10                                          | 20x85  | 85                        | 1,5                        | 1,5       | 1,2        | 1,5                        | 1,5       | 1,2        | 6,5                       |
|                                                                     | 20x130 | 130                       | 3,0                        | 3,0       | 2,0        | 3,0                        | 3,0       | 2,0        | 6,5                       |

<sup>1)</sup> Values are valid for  $C_{Cr}$  and  $C_{min}$

<sup>2)</sup> Calculation of  $V_{RK,c}$  see Technical Report TR 054, except for shear load parallel to free edge with  $c \geq 120 \text{ mm}$ :  $V_{RK,c,II} = V_{RK,b}$

<sup>3)</sup> The values are valid for steel 5.6 or greater. For steel 4.6 and 4.8 multiply  $V_{RK,b}$  by 0,8

**ESSVE Injection system ONE, ONE ICE for masonry**

**Performances calcium hollow brick KS L-12DF**

Installation parameters (continue)

Characteristic values of resistance under tension and shear load

**Annex C 13**

**Brick type: Calcium silicate hollow brick KS L-12DF**

**Table C32: Characteristic values of resistance under tension and shear loads (continue)**

| Anchor size                                                         | Sleeve | Effective anchorage depth | Characteristic resistance  |           |            |                            |           |            |                           |
|---------------------------------------------------------------------|--------|---------------------------|----------------------------|-----------|------------|----------------------------|-----------|------------|---------------------------|
|                                                                     |        |                           | Use category               |           |            |                            |           |            |                           |
|                                                                     |        |                           | d/d                        |           |            | w/d<br>w/w                 |           |            | d/d<br>w/d<br>w/w         |
|                                                                     |        |                           | 40°C/24°C                  | 80°C/50°C | 120°C/72°C | 40°C/24°C                  | 80°C/50°C | 120°C/72°C | For all temperature range |
|                                                                     |        | $h_{ef}$                  | $N_{Rk,b} = N_{Rk,p}^{1)}$ |           |            | $N_{Rk,b} = N_{Rk,p}^{1)}$ |           |            | $V_{Rk,b}^{2)3)}$         |
|                                                                     |        | [mm]                      | [kN]                       |           |            |                            |           |            |                           |
| <b>Compressive strength <math>f_b \geq 16 \text{ N/mm}^2</math></b> |        |                           |                            |           |            |                            |           |            |                           |
| M8                                                                  | 12x80  | 80                        | 0,9                        | 0,9       | 0,6        | 0,75                       | 0,75      | 0,5        | 3,5                       |
| M8 / M10 /<br>IG-M6                                                 | 16x85  | 85                        | 0,9                        | 0,9       | 0,6        | 0,9                        | 0,9       | 0,6        | 8,0                       |
|                                                                     | 16x130 | 130                       | 4,0                        | 3,5       | 2,5        | 4,0                        | 3,5       | 2,5        | 8,0                       |
| M12 / M16 /<br>IG-M8 /<br>IG-M10                                    | 20x85  | 85                        | 2,0                        | 2,0       | 1,5        | 2,0                        | 2,0       | 1,5        | 8,0                       |
|                                                                     | 20x130 | 130                       | 4,0                        | 3,5       | 2,5        | 4,0                        | 3,5       | 2,5        | 8,0                       |

1) Values are valid for  $C_{cr}$  and  $C_{min}$

2) Calculation of  $V_{Rk,c}$  see Technical Report TR 054, except for shear load parallel to free edge with  $c \geq 120 \text{ mm}$ :  $V_{Rk,c,II} = V_{Rk,b}$

3) The values are valid for steel 5.6 or greater. For steel 4.6 and 4.8 multiply  $V_{Rk,b}$  by 0,8

**Table C33: Displacements**

| Anchor size         | Sleeve                           | Effective anchorage depth<br>$h_{ef}$<br>[mm] | N<br>[kN] | $\delta_N / N$<br>[mm/kN] | $\delta_{N0}$<br>[mm] | $\delta_{N\infty}$<br>[mm] | V<br>[kN] | $\delta_{V0}$<br>[mm] | $\delta_{V\infty}$<br>[mm] |
|---------------------|----------------------------------|-----------------------------------------------|-----------|---------------------------|-----------------------|----------------------------|-----------|-----------------------|----------------------------|
|                     |                                  |                                               |           |                           |                       |                            |           |                       |                            |
| M8 / M10 /<br>IG-M6 | 16x85                            | 85                                            | 1,14      | 1,03                      | 2,06                  |                            |           |                       |                            |
|                     | M12 / M16<br>/ IG-M8 /<br>IG-M10 | 16x130                                        | 130       | 0,57                      | 0,51                  | 1,03                       | 2,3       | 2,5                   | 3,75                       |
| 20x85               |                                  | 85                                            | 1,14      | 1,03                      | 2,06                  |                            |           |                       |                            |
|                     | 20x130                           | 130                                           |           |                           |                       |                            |           |                       |                            |

**ESSVE Injection system ONE, ONE ICE for masonry**

**Performances calcium hollow brick KS L-12DF**

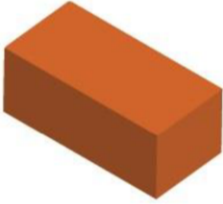
Characteristic values of resistance under tension and shear load (continue)

Displacements

**Annex C 14**

**Brick type: Clay solid brick Mz-DF**

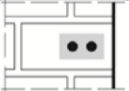
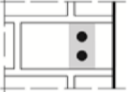
**Table C34: Description of the brick**

|                                                      |                           |                                                                                     |
|------------------------------------------------------|---------------------------|-------------------------------------------------------------------------------------|
| Brick type                                           | Clay solid brick<br>Mz-DF |  |
| Bulk density $\rho$ [kg/dm <sup>3</sup> ]            | 1,6                       |                                                                                     |
| Compressive strength $f_b \geq$ [N/mm <sup>2</sup> ] | 10, 20 or 28              |                                                                                     |
| Code                                                 | EN 771-1                  |                                                                                     |
| Producer (country code)                              | e.g. Unipor (DE)          |                                                                                     |
| Brick dimensions [mm]                                | 240 x 115 x 55            |                                                                                     |
| Drilling method                                      | Hammer                    |                                                                                     |

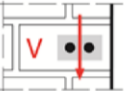

**Table C35: Installation parameter**

|                       |           |      |                    |
|-----------------------|-----------|------|--------------------|
| Anchor size           |           | [-]  | All sizes          |
| Edge distance         | $c_{cr}$  | [mm] | $1,5 \cdot h_{ef}$ |
| Minimum edge distance | $c_{min}$ | [mm] | 60                 |
| Spacing               | $s_{cr}$  | [mm] | $3 \cdot h_{ef}$   |
| Minimum spacing       | $s_{min}$ | [mm] | 120                |

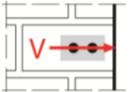
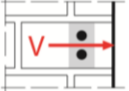
**Table C36: Group factor for anchor group in case of tension loading**

| Configuration                                       |                                                                                     | with $c \geq$      | with $s \geq$    |                      |     |     |
|-----------------------------------------------------|-------------------------------------------------------------------------------------|--------------------|------------------|----------------------|-----|-----|
| II: anchors placed parallel to horizontal joint     |  | 60                 | 120              | $\alpha_{g,N,II}$    | [-] | 0,7 |
|                                                     |                                                                                     | $1,5 \cdot h_{ef}$ | $3 \cdot h_{ef}$ |                      |     | 2,0 |
| ⊥: anchors placed perpendicular to horizontal joint |  | 60                 | 120              | $\alpha_{g,N,\perp}$ | [-] | 0,5 |
|                                                     |                                                                                     | $1,5 \cdot h_{ef}$ | 120              |                      |     | 1,0 |
|                                                     |                                                                                     | $1,5 \cdot h_{ef}$ | $3 \cdot h_{ef}$ |                      |     | 2,0 |

**Table C37: Group factor for anchor group in case of shear loading parallel to free edge**

| Configuration                                       |                                                                                     | with $c \geq$      | with $s \geq$    |                      |     |     |
|-----------------------------------------------------|-------------------------------------------------------------------------------------|--------------------|------------------|----------------------|-----|-----|
| II: anchors placed parallel to horizontal joint     |  | 60                 | 120              | $\alpha_{g,V,II}$    | [-] | 0,5 |
|                                                     |                                                                                     | 90                 | 120              |                      |     | 1,1 |
|                                                     |                                                                                     | $1,5 \cdot h_{ef}$ | $3 \cdot h_{ef}$ |                      |     | 2,0 |
| ⊥: anchors placed perpendicular to horizontal joint |  | 60                 | 120              | $\alpha_{g,V,\perp}$ | [-] | 0,5 |
|                                                     |                                                                                     | $1,5 \cdot h_{ef}$ | 120              |                      |     | 1,0 |
|                                                     |                                                                                     | $1,5 \cdot h_{ef}$ | $3 \cdot h_{ef}$ |                      |     | 2,0 |

**Table C38: Group factor for anchor group in case of shear loading perpendicular to free edge**

| Configuration                                       |                                                                                     | with $c \geq$      | with $s \geq$    |                      |     |     |
|-----------------------------------------------------|-------------------------------------------------------------------------------------|--------------------|------------------|----------------------|-----|-----|
| II: anchors placed parallel to horizontal joint     |  | 60                 | 120              | $\alpha_{g,V,II}$    | [-] | 0,5 |
|                                                     |                                                                                     | $1,5 \cdot h_{ef}$ | 120              |                      |     | 1,0 |
|                                                     |                                                                                     | $1,5 \cdot h_{ef}$ | $3 \cdot h_{ef}$ |                      |     | 2,0 |
| ⊥: anchors placed perpendicular to horizontal joint |  | 60                 | 120              | $\alpha_{g,V,\perp}$ | [-] | 0,5 |
|                                                     |                                                                                     | $1,5 \cdot h_{ef}$ | 120              |                      |     | 1,0 |
|                                                     |                                                                                     | $1,5 \cdot h_{ef}$ | $3 \cdot h_{ef}$ |                      |     | 2,0 |

**ESSVE Injection system ONE, ONE ICE for masonry**

**Performances clay solid brick Mz-DF**

Description of the brick  
Installation parameters

**Annex C 15**



**Brick type: Clay solid brick Mz-DF**

**Table C39: Characteristic values of resistance under tension and shear loads**

| Anchor size                                                                                                                                                                                                                                                                                                                                                               | Sleeve | Effective anchorage depth  | Characteristic resistance |           |                   |                           |
|---------------------------------------------------------------------------------------------------------------------------------------------------------------------------------------------------------------------------------------------------------------------------------------------------------------------------------------------------------------------------|--------|----------------------------|---------------------------|-----------|-------------------|---------------------------|
|                                                                                                                                                                                                                                                                                                                                                                           |        |                            | Use category              |           |                   |                           |
|                                                                                                                                                                                                                                                                                                                                                                           |        |                            | d/d<br>w/d<br>w/w         |           |                   | d/d<br>w/d<br>w/w         |
|                                                                                                                                                                                                                                                                                                                                                                           |        |                            | 40°C/24°C                 | 80°C/50°C | 120°C/72°C        | For all temperature range |
| $h_{ef}$                                                                                                                                                                                                                                                                                                                                                                  |        | $N_{Rk,b} = N_{Rk,p}^{1)}$ |                           |           | $V_{Rk,b}^{2)3)}$ |                           |
| [mm]                                                                                                                                                                                                                                                                                                                                                                      |        | [kN]                       |                           |           |                   |                           |
| <b>Compressive strength <math>f_b \geq 10 \text{ N/mm}^2</math></b>                                                                                                                                                                                                                                                                                                       |        |                            |                           |           |                   |                           |
| M8                                                                                                                                                                                                                                                                                                                                                                        | -      | 80                         | 3,5 (1,5)                 | 3,5 (1,5) | 2,5 (1,2)         | 3,5 (1,2)                 |
| M10 / IG-M6                                                                                                                                                                                                                                                                                                                                                               | -      | 90                         | 3,5 (1,5)                 | 3,5 (1,5) | 3,0 (1,5)         | 3,5 (1,2)                 |
| M12 / IG-M8                                                                                                                                                                                                                                                                                                                                                               | -      | 100                        | 4,0 (2,0)                 | 4,0 (2,0) | 3,5 (1,5)         | 3,5 (1,2)                 |
| M16 / IG-M10                                                                                                                                                                                                                                                                                                                                                              | -      | 100                        | 4,0 (2,0)                 | 4,0 (2,0) | 3,5 (1,5)         | 5,5 (1,5)                 |
| M8                                                                                                                                                                                                                                                                                                                                                                        | 12x80  | 80                         | 3,5 (1,5)                 | 3,5 (1,5) | 3,0 (1,2)         | 3,5 (1,2)                 |
| M8 / M10 / IG-M6                                                                                                                                                                                                                                                                                                                                                          | 16x85  | 85                         | 3,5 (1,5)                 | 3,5 (1,5) | 3,0 (1,5)         | 3,5 (1,2)                 |
|                                                                                                                                                                                                                                                                                                                                                                           | 16x130 | 130                        | 3,5 (1,5)                 | 3,5 (1,5) | 3,0 (1,5)         | 3,5 (1,2)                 |
| M12 / M16 / IG-M8 / IG-M10                                                                                                                                                                                                                                                                                                                                                | 20x85  | 85                         | 3,5 (1,5)                 | 3,5 (1,5) | 3,0 (1,5)         | 3,5 (1,2)                 |
|                                                                                                                                                                                                                                                                                                                                                                           | 20x130 | 130                        | 3,5 (1,5)                 | 3,5 (1,5) | 3,0 (1,5)         | 3,5 (1,2)                 |
|                                                                                                                                                                                                                                                                                                                                                                           | 20x200 | 200                        | 3,5 (1,5)                 | 3,5 (1,5) | 3,0 (1,5)         | 3,5 (1,2)                 |
| <b>Compressive strength <math>f_b \geq 20 \text{ N/mm}^2</math></b>                                                                                                                                                                                                                                                                                                       |        |                            |                           |           |                   |                           |
| M8                                                                                                                                                                                                                                                                                                                                                                        | -      | 80                         | 4,5 (2,5)                 | 4,5 (2,5) | 4,0 (2,0)         | 5,0 (1,5)                 |
| M10 / IG-M6                                                                                                                                                                                                                                                                                                                                                               | -      | 90                         | 5,5 (2,5)                 | 5,5 (2,5) | 4,5 (2,0)         | 5,0 (1,5)                 |
| M12 / IG-M8                                                                                                                                                                                                                                                                                                                                                               | -      | 100                        | 6,0 (3,0)                 | 6,0 (3,0) | 5,0 (2,5)         | 5,0 (1,5)                 |
| M16 / IG-M10                                                                                                                                                                                                                                                                                                                                                              | -      | 100                        | 6,0 (3,0)                 | 6,0 (3,0) | 5,0 (2,5)         | 8,0 (2,5)                 |
| M8                                                                                                                                                                                                                                                                                                                                                                        | 12x80  | 80                         | 4,5 (2,5)                 | 4,5 (2,5) | 4,0 (2,0)         | 5,0 (1,5)                 |
| M8 / M10 / IG-M6                                                                                                                                                                                                                                                                                                                                                          | 16x85  | 85                         | 5,0 (2,5)                 | 5,0 (2,5) | 4,0 (2,0)         | 5,0 (1,5)                 |
|                                                                                                                                                                                                                                                                                                                                                                           | 16x130 | 130                        | 5,0 (2,5)                 | 5,0 (2,5) | 4,0 (2,0)         | 5,0 (1,5)                 |
| M12 / M16 / IG-M8 / IG-M10                                                                                                                                                                                                                                                                                                                                                | 20x85  | 85                         | 5,0 (2,5)                 | 5,0 (2,5) | 4,0 (2,0)         | 5,0 (1,5)                 |
|                                                                                                                                                                                                                                                                                                                                                                           | 20x130 | 130                        | 5,0 (2,5)                 | 5,0 (2,5) | 4,0 (2,0)         | 5,0 (1,5)                 |
|                                                                                                                                                                                                                                                                                                                                                                           | 20x200 | 200                        | 5,0 (2,5)                 | 5,0 (2,5) | 4,0 (2,0)         | 5,0 (1,5)                 |
| <b>Compressive strength <math>f_b \geq 28 \text{ N/mm}^2</math></b>                                                                                                                                                                                                                                                                                                       |        |                            |                           |           |                   |                           |
| M8                                                                                                                                                                                                                                                                                                                                                                        | -      | 80                         | 5,5 (2,5)                 | 5,5 (2,5) | 4,5 (2,5)         | 5,5 (2,0)                 |
| M10 / IG-M6                                                                                                                                                                                                                                                                                                                                                               | -      | 90                         | 6,0 (3,0)                 | 6,0 (3,0) | 5,0 (2,5)         | 5,5 (2,0)                 |
| M12 / IG-M8                                                                                                                                                                                                                                                                                                                                                               | -      | 100                        | 7,0 (3,5)                 | 7,0 (3,5) | 6,0 (3,0)         | 5,5 (2,0)                 |
| M16 / IG-M10                                                                                                                                                                                                                                                                                                                                                              | -      | 100                        | 7,0 (3,5)                 | 7,0 (3,5) | 6,0 (3,0)         | 9,0 (3,0)                 |
| M8                                                                                                                                                                                                                                                                                                                                                                        | 12x80  | 80                         | 5,5 (2,5)                 | 5,5 (2,5) | 4,5 (2,5)         | 5,5 (2,0)                 |
| M8 / M10 / IG-M6                                                                                                                                                                                                                                                                                                                                                          | 16x85  | 85                         | 6,0 (3,0)                 | 6,0 (3,0) | 5,0 (2,5)         | 5,5 (2,0)                 |
|                                                                                                                                                                                                                                                                                                                                                                           | 16x130 | 130                        | 6,0 (3,0)                 | 6,0 (3,0) | 5,0 (2,5)         | 5,5 (2,0)                 |
| M12 / M16 / IG-M8 / IG-M10                                                                                                                                                                                                                                                                                                                                                | 20x85  | 85                         | 6,0 (3,0)                 | 6,0 (3,0) | 5,0 (2,5)         | 5,5 (2,0)                 |
|                                                                                                                                                                                                                                                                                                                                                                           | 20x130 | 130                        | 6,0 (3,0)                 | 6,0 (3,0) | 5,0 (2,5)         | 5,5 (2,0)                 |
|                                                                                                                                                                                                                                                                                                                                                                           | 20x200 | 200                        | 6,0 (3,0)                 | 6,0 (3,0) | 5,0 (2,5)         | 5,5 (2,0)                 |
| <sup>1)</sup> Values are valid for $c_{cr}$ , values in brackets are valid for single anchors with $c_{min}$<br><sup>2)</sup> For $c_{cr}$ calculation of $V_{Rk,c}$ see Technical Report TR 054; for $c_{min}$ values in brackets $V_{Rk,b} = V_{Rk,c}$<br><sup>3)</sup> The values are valid for steel 5.6 or greater. For steel 4.6 and 4.8 multiply $V_{Rk,b}$ by 0,8 |        |                            |                           |           |                   |                           |
| <b>ESSVE Injection system ONE, ONE ICE for masonry</b>                                                                                                                                                                                                                                                                                                                    |        |                            |                           |           | <b>Annex C 16</b> |                           |
| <b>Performances clay solid brick Mz-DF</b>                                                                                                                                                                                                                                                                                                                                |        |                            |                           |           |                   |                           |
| Characteristic values of resistance under tension and shear load                                                                                                                                                                                                                                                                                                          |        |                            |                           |           |                   |                           |

**Brick type: Clay solid brick Mz-DF**

**Table C40: Displacements**

| Anchor size                | Sleeve | Effective anchorage depth $h_{ef}$ | N    | $\delta_N / N$ | $\delta_{N0}$ | $\delta_{N\infty}$ | V    | $\delta_{V0}$ | $\delta_{V\infty}$ |
|----------------------------|--------|------------------------------------|------|----------------|---------------|--------------------|------|---------------|--------------------|
|                            |        | [mm]                               | [kN] | [mm/kN]        | [mm]          | [mm]               | [kN] | [mm]          | [mm]               |
| M8                         | -      | 80                                 | 1,3  | 0,15           | 0,19          | 0,39               | 1,9  | 1,00          | 1,50               |
| M10 / IG-M6                | -      | 90                                 | 1,6  |                | 0,24          | 0,47               |      |               |                    |
| M12 / IG-M8                | -      | 100                                | 1,7  |                | 0,26          | 0,51               |      |               |                    |
| M16 / IG-M10               | -      | 100                                |      |                |               |                    |      |               |                    |
| M8                         | 12x80  | 80                                 | 1,3  |                | 0,19          | 0,39               | 1,9  |               |                    |
| M8 / M10 / IG-M6           | 16x85  | 85                                 |      |                |               |                    |      |               |                    |
|                            | 16x130 | 130                                |      |                |               |                    |      |               |                    |
| M12 / M16 / IG-M8 / IG-M10 | 20x85  | 85                                 |      |                |               |                    |      |               |                    |
|                            | 20x130 | 130                                |      |                |               |                    |      |               |                    |
|                            | 20x200 | 200                                |      |                |               |                    |      |               |                    |

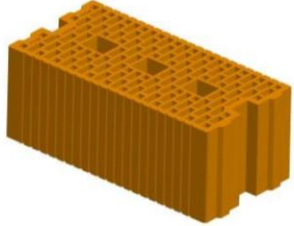
**ESSVE Injection system ONE, ONE ICE for masonry**

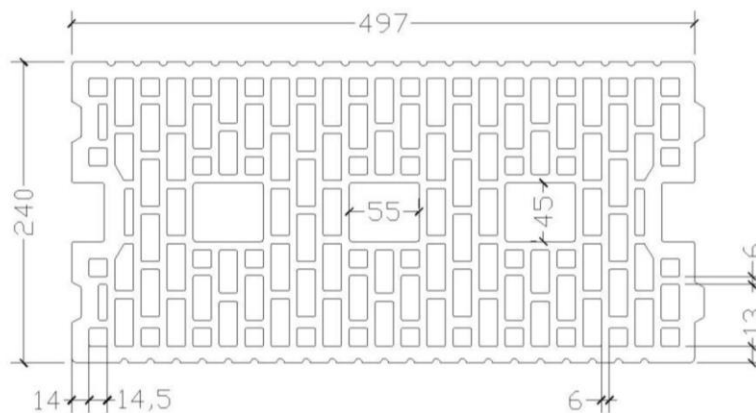
**Performances clay solid brick Mz-DF**  
Displacements

**Annex C 17**

**Brick type: Clay hollow brick HLz-16-DF**

**Table C41: Description of the brick**

|                                                      |                                |                                                                                     |
|------------------------------------------------------|--------------------------------|-------------------------------------------------------------------------------------|
| Brick type                                           | Clay hollow brick<br>HLz-16-DF |  |
| Bulk density $\rho$ [kg/dm <sup>3</sup> ]            | 0,8                            |                                                                                     |
| Compressive strength $f_b \geq$ [N/mm <sup>2</sup> ] | 6, 8, 12, 14                   |                                                                                     |
| Code                                                 | EN 771-1                       |                                                                                     |
| Producer (country code)                              | e.g. Unipor DE                 |                                                                                     |
| Brick dimensions [mm]                                | 497 x 240 x 238                |                                                                                     |
| Drilling method                                      | Rotary                         |                                                                                     |



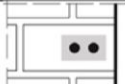
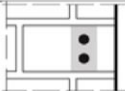
**Table C42: Installation parameters**

| Anchor size           |                         | [-]  | All sizes               |
|-----------------------|-------------------------|------|-------------------------|
| Edge distance         | $C_{cr}$                | [mm] | 100 (120) <sup>1)</sup> |
| Minimum edge distance | $C_{min}$ <sup>2)</sup> | [mm] | 100 (120) <sup>1)</sup> |
| Spacing               | $S_{cr,II}$             | [mm] | 497                     |
|                       | $S_{cr,I}$              | [mm] | 238                     |
| Minimum spacing       | $S_{min}$               | [mm] | 100                     |

<sup>1)</sup> Value in brackets for SH20x85; SH20x130 and SH20x200

<sup>2)</sup> For  $V_{Rk,c}$ :  $C_{min}$  according to Technical Report TR 054

**Table C43: Group factor for anchor group in case of tension loading**

| Configuration                                       |                                                                                     | with $c \geq$ | with $s \geq$ |                   |     |     |
|-----------------------------------------------------|-------------------------------------------------------------------------------------|---------------|---------------|-------------------|-----|-----|
| II: anchors placed parallel to horizontal joint     |  | $C_{cr}$      | 100           | $\alpha_{g,N,II}$ | [-] | 1,3 |
|                                                     |                                                                                     | $C_{cr}$      | 497           |                   |     | 2,0 |
| I: anchors placed perpendicular to horizontal joint |  | $C_{cr}$      | 100           | $\alpha_{g,N,I}$  | [-] | 1,1 |
|                                                     |                                                                                     | $C_{cr}$      | 238           |                   |     | 2,0 |

**ESSVE Injection system ONE, ONE ICE for masonry**

**Performances clay hollow brick HLz-16DF**

Description of the brick  
Installation parameters

**Annex C 18**

**Brick type: Clay hollow brick HLz-16-DF**

**Table C44: Group factor for anchor group in case of shear loading parallel to free edge**

| Configuration                                       |  | with $c \geq$ | with $s \geq$ |                      |     |     |
|-----------------------------------------------------|--|---------------|---------------|----------------------|-----|-----|
| II: anchors placed parallel to horizontal joint     |  | $C_{cr}$      | 497           | $\alpha_{g,V,II}$    | [-] | 2,0 |
| ⊥: anchors placed perpendicular to horizontal joint |  | $C_{cr}$      | 238           | $\alpha_{g,V,\perp}$ |     | 2,0 |

**Table C45: Group factor for anchor group in case of shear loading perpendicular to free edge**

| Configuration                                       |  | with $c \geq$ | with $s \geq$ |                      |     |     |
|-----------------------------------------------------|--|---------------|---------------|----------------------|-----|-----|
| II: anchors placed parallel to horizontal joint     |  | $C_{cr}$      | 497           | $\alpha_{g,V,II}$    | [-] | 2,0 |
| ⊥: anchors placed perpendicular to horizontal joint |  | $C_{cr}$      | 238           | $\alpha_{g,V,\perp}$ |     | 2,0 |

**Table C46: Characteristic values of resistance under tension and shear loads**

| Anchor size                                                        | Sleeve | Effective anchorage depth | Characteristic resistance  |           |            |                           |
|--------------------------------------------------------------------|--------|---------------------------|----------------------------|-----------|------------|---------------------------|
|                                                                    |        |                           | Use category               |           |            |                           |
|                                                                    |        |                           | d/d<br>w/d<br>w/w          |           |            | d/d<br>w/d<br>w/w         |
|                                                                    |        |                           | 40°C/24°C                  | 80°C/50°C | 120°C/72°C | For all temperature range |
|                                                                    |        | $h_{ef}$                  | $N_{Rk,b} = N_{Rk,p}^{1)}$ |           |            | $V_{Rk,b}^{2)3)}$         |
|                                                                    |        | [mm]                      | [kN]                       |           |            |                           |
| <b>Compressive strength <math>f_b \geq 6 \text{ N/mm}^2</math></b> |        |                           |                            |           |            |                           |
| M8                                                                 | 12x80  | 80                        | 2,5                        | 2,5       | 2,0        | 2,5                       |
| M8 / M10/<br>IG-M6                                                 | 16x85  | 85                        | 2,5                        | 2,5       | 2,0        | 4,5                       |
|                                                                    | 16x130 | 130                       | 3,5                        | 3,5       | 3,0        | 4,5                       |
| M12 / M16 /<br>IG-M8 / IG-M10                                      | 20x85  | 85                        | 2,5                        | 2,5       | 2,0        | 5,0                       |
|                                                                    | 20x130 | 130                       | 3,5                        | 3,5       | 3,0        | 6,0                       |
|                                                                    | 20x200 | 200                       | 3,5                        | 3,5       | 3,0        | 6,0                       |
| <b>Compressive strength <math>f_b \geq 8 \text{ N/mm}^2</math></b> |        |                           |                            |           |            |                           |
| M8                                                                 | 12x80  | 80                        | 3,0                        | 3,0       | 2,5        | 3,0                       |
| M8 / M10/<br>IG-M6                                                 | 16x85  | 85                        | 3,0                        | 3,0       | 2,5        | 5,5                       |
|                                                                    | 16x130 | 130                       | 4,5                        | 4,5       | 3,5        | 5,5                       |
| M12 / M16 /<br>IG-M8 / IG-M10                                      | 20x85  | 85                        | 3,0                        | 3,0       | 2,5        | 6,0                       |
|                                                                    | 20x130 | 130                       | 4,5                        | 4,5       | 3,5        | 7,0                       |
|                                                                    | 20x200 | 200                       | 4,5                        | 4,5       | 3,5        | 7,0                       |

1) Values are valid for  $C_{cr}$  and  $C_{min}$

2) Calculation of  $V_{Rk,c}$  see Technical Report TR 054, except for shear load parallel to free edge with  $c \geq 125 \text{ mm}$ :  $V_{Rk,c,II} = V_{Rk,b}$

3) The values are valid for steel 5.6 or greater. For steel 4.6 and 4.8 multiply  $V_{Rk,b}$  by 0,8

**ESSVE Injection system ONE, ONE ICE for masonry**

**Performances clay hollow brick HLz-16DF**

Installation parameters (continue)

Characteristic values of resistance under tension and shear load

**Annex C 19**

**Brick type: Clay hollow brick HLz-16-DF**

**Table C47: Characteristic values of resistance under tension and shear loads (continue)**

| Anchor size                                                         | Sleeve | Effective anchorage depth  | Characteristic resistance |           |                   |                           |
|---------------------------------------------------------------------|--------|----------------------------|---------------------------|-----------|-------------------|---------------------------|
|                                                                     |        |                            | Use category              |           |                   |                           |
|                                                                     |        |                            | d/d<br>w/d<br>w/w         |           |                   | d/d<br>w/d<br>w/w         |
|                                                                     |        |                            | 40°C/24°C                 | 80°C/50°C | 120°C/72°C        | For all temperature range |
| $h_{ef}$                                                            |        | $N_{Rk,b} = N_{Rk,p}^{1)}$ |                           |           | $V_{Rk,b}^{2)3)}$ |                           |
| [mm]                                                                |        | [kN]                       |                           |           |                   |                           |
| <b>Compressive strength <math>f_b \geq 12 \text{ N/mm}^2</math></b> |        |                            |                           |           |                   |                           |
| M8                                                                  | 12x80  | 80                         | 3,5                       | 3,5       | 3,0               | 4,0                       |
| M8 / M10/<br>IG-M6                                                  | 16x85  | 85                         | 3,5                       | 3,5       | 3,0               | 6,5                       |
|                                                                     | 16x130 | 130                        | 5,0                       | 5,0       | 4,5               | 6,5                       |
| M12 / M16 /<br>IG-M8 / IG-M10                                       | 20x85  | 85                         | 3,5                       | 3,5       | 3,0               | 7,0                       |
|                                                                     | 20x130 | 130                        | 5,0                       | 5,0       | 4,5               | 9,0                       |
|                                                                     | 20x200 | 200                        | 5,0                       | 5,0       | 4,5               | 9,0                       |
| <b>Compressive strength <math>f_b \geq 14 \text{ N/mm}^2</math></b> |        |                            |                           |           |                   |                           |
| M8                                                                  | 12x80  | 80                         | 4,0                       | 4,0       | 3,0               | 4,0                       |
| M8 / M10/<br>IG-M6                                                  | 16x85  | 85                         | 4,0                       | 4,0       | 3,0               | 6,5                       |
|                                                                     | 16x130 | 130                        | 5,5                       | 5,5       | 4,5               | 6,5                       |
| M12 / M16 /<br>IG-M8 / IG-M10                                       | 20x85  | 85                         | 4,0                       | 4,0       | 3,0               | 7,0                       |
|                                                                     | 20x130 | 130                        | 5,5                       | 5,5       | 4,5               | 9,0                       |
|                                                                     | 20x200 | 200                        | 5,5                       | 5,5       | 4,5               | 9,0                       |

1) Values are valid for  $c_{cr}$  and  $c_{min}$

2) Calculation of  $V_{Rk,c}$  see Technical Report TR 054, except for shear load parallel to free edge with  $c \geq 125 \text{ mm}$ :  $V_{Rk,c,II} = V_{Rk,b}$

3) The values are valid for steel 5.6 or greater. For steel 4.6 and 4.8 multiply  $V_{Rk,b}$  by 0,8

**Table C48: Displacements**

| Anchor size                      | Sleeve | Effective anchorage depth $h_{ef}$ | N    | $\delta_N / N$ | $\delta_{N0}$ | $\delta_{N\infty}$ | V    | $\delta_{V0}$ | $\delta_{V\infty}$ |
|----------------------------------|--------|------------------------------------|------|----------------|---------------|--------------------|------|---------------|--------------------|
|                                  |        |                                    |      |                |               |                    |      |               |                    |
| M8                               | 12x80  | 80                                 | 1,14 | 0,10           | 0,11          | 0,23               | 1,10 | 1,20          | 1,80               |
| M8 / M10/<br>IG-M6               | 16x85  | 85                                 |      |                |               |                    |      |               |                    |
|                                  | 16x130 | 130                                | 1,57 |                | 0,16          | 0,31               | 1,86 | 1,50          | 2,25               |
| M12 / M16 /<br>IG-M8 /<br>IG-M10 | 20x85  | 85                                 | 1,14 |                | 0,11          | 0,23               | 1,86 | 1,50          | 2,25               |
|                                  | 20x130 | 130                                | 1,57 |                | 0,16          | 0,31               | 2,57 | 2,10          | 3,15               |
|                                  | 20x200 | 200                                |      |                |               |                    |      |               |                    |

**ESSVE Injection system ONE, ONE ICE for masonry**

**Performances clay hollow brick HLz-16DF**

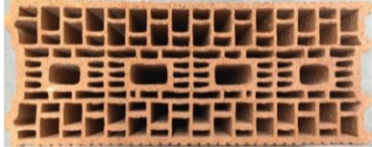
Characteristic values of resistance under tension and shear load (continue)

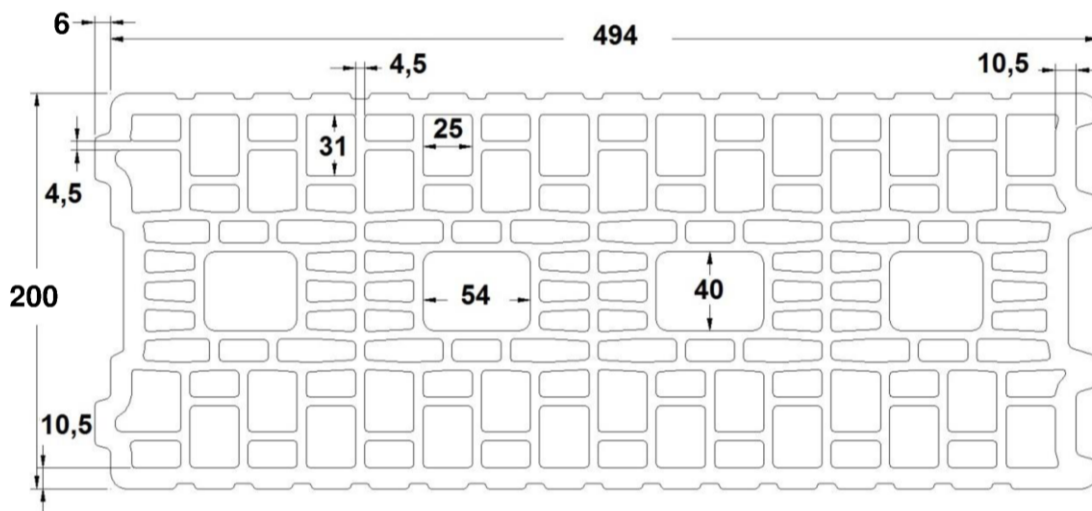
Displacements

**Annex C 20**

**Brick type: Clay hollow brick Porotherm Homebric**

**Table C49: Description of the brick**

|                                                      |                                                |                                                                                     |
|------------------------------------------------------|------------------------------------------------|-------------------------------------------------------------------------------------|
| Brick type                                           | Clay hollow hollow brick<br>Porotherm Homebric |  |
| Bulk density $\rho$ [kg/dm <sup>3</sup> ]            | 0,7                                            |                                                                                     |
| Compressive strength $f_b \geq$ [N/mm <sup>2</sup> ] | 4, 6 or 10                                     |                                                                                     |
| Code                                                 | EN 771-1                                       |                                                                                     |
| Producer (country code)                              | e.g. Wienerberger (FR)                         |                                                                                     |
| Brick dimensions [mm]                                | 500 x 200 x 299                                |                                                                                     |
| Drilling method                                      | Rotary                                         |                                                                                     |



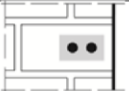
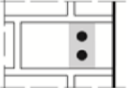
**Table C50: Installation parameters**

| Anchor size           |                         | [-]  | All sizes               |
|-----------------------|-------------------------|------|-------------------------|
| Edge distance         | $C_{cr}$                | [mm] | 100 (120) <sup>1)</sup> |
| Minimum edge distance | $C_{min}$ <sup>2)</sup> | [mm] | 100 (120) <sup>1)</sup> |
| Spacing               | $S_{cr,II}$             | [mm] | 500                     |
|                       | $S_{cr,\perp}$          | [mm] | 299                     |
| Minimum spacing       | $S_{min}$               | [mm] | 100                     |

<sup>1)</sup> Value in brackets for SH20x85 and SH20x130

<sup>2)</sup> For  $V_{Rk,c}$ :  $C_{min}$  according to Technical Report TR 054

**Table C51: Group factor for anchor group in case of tension loading**

| Configuration                                       |                                                                                     | with $c \geq$ | with $s \geq$ |                      |     |     |
|-----------------------------------------------------|-------------------------------------------------------------------------------------|---------------|---------------|----------------------|-----|-----|
| II: anchors placed parallel to horizontal joint     |  | 200           | 100           | $\alpha_{g,N,II}$    | [-] | 2,0 |
|                                                     |                                                                                     | $C_{cr}$      | 500           |                      |     | 2,0 |
| ⊥: anchors placed perpendicular to horizontal joint |  | 200           | 100           | $\alpha_{g,N,\perp}$ |     | 1,2 |
|                                                     |                                                                                     | $C_{cr}$      | 299           |                      |     | 2,0 |

**ESSVE Injection system ONE, ONE ICE for masonry**

**Performances clay hollow brick Porotherm Homebric**

Description of the brick  
Installation parameters

**Annex C 21**

**Brick type: Clay silicate hollow brick Porotherm Homebric**

**Table C52: Group factor for anchor group in case of shear loading parallel to free edge**

| Configuration                                       |  | with $c \geq$ | with $s \geq$ |                   |     |     |
|-----------------------------------------------------|--|---------------|---------------|-------------------|-----|-----|
| II: anchors placed parallel to horizontal joint     |  | $C_{cr}$      | 500           | $\alpha_{g,V,II}$ | [-] | 2,0 |
| I: anchors placed perpendicular to horizontal joint |  | $C_{cr}$      | 299           | $\alpha_{g,V,I}$  |     | 2,0 |

**Table C53: Group factor for anchor group in case of shear loading perpendicular to free edge**

| Configuration                                       |  | with $c \geq$ | with $s \geq$ |                   |     |     |
|-----------------------------------------------------|--|---------------|---------------|-------------------|-----|-----|
| II: anchors placed parallel to horizontal joint     |  | $C_{cr}$      | 500           | $\alpha_{g,V,II}$ | [-] | 2,0 |
| I: anchors placed perpendicular to horizontal joint |  | $C_{cr}$      | 299           | $\alpha_{g,V,I}$  |     | 2,0 |

**Table C54: Characteristic values of resistance under tension and shear loads**

| Anchor size                                                        | Sleeve                     | Effective anchorage depth | Characteristic resistance |                   |            |                           |
|--------------------------------------------------------------------|----------------------------|---------------------------|---------------------------|-------------------|------------|---------------------------|
|                                                                    |                            |                           | Use category              |                   |            |                           |
|                                                                    |                            |                           | d/d<br>w/d<br>w/w         |                   |            | d/d<br>w/d<br>w/w         |
|                                                                    |                            |                           | 40°C/24°C                 | 80°C/50°C         | 120°C/72°C | For all temperature range |
| $h_{ef}$                                                           | $N_{Rk,b} = N_{Rk,p}^{1)}$ |                           |                           | $V_{Rk,b}^{2)3)}$ |            |                           |
| [mm]                                                               | [kN]                       |                           |                           |                   |            |                           |
| <b>Compressive strength <math>f_b \geq 4 \text{ N/mm}^2</math></b> |                            |                           |                           |                   |            |                           |
| M8                                                                 | 12x80                      | 80                        | 0,9                       | 0,9               | 0,75       | 2,0                       |
| M8 / M10/ IG-M6                                                    | 16x85                      | 85                        | 0,9                       | 0,9               | 0,75       | 2,0                       |
|                                                                    | 16x130                     | 130                       | 1,2                       | 1,2               | 0,9        | 2,0                       |
| M12 / M16 / IG-M8 / IG-M10                                         | 20x85                      | 85                        | 0,9                       | 0,9               | 0,75       | 2,5                       |
|                                                                    | 20x130                     | 130                       | 1,2                       | 1,2               | 0,9        | 2,5                       |
| <b>Compressive strength <math>f_b \geq 6 \text{ N/mm}^2</math></b> |                            |                           |                           |                   |            |                           |
| M8                                                                 | 12x80                      | 80                        | 0,9                       | 0,9               | 0,9        | 2,5                       |
| M8 / M10/ IG-M6                                                    | 16x85                      | 85                        | 0,9                       | 0,9               | 0,9        | 2,5                       |
|                                                                    | 16x130                     | 130                       | 1,2                       | 1,2               | 1,2        | 2,5                       |
| M12 / M16 / IG-M8 / IG-M10                                         | 20x85                      | 85                        | 0,9                       | 0,9               | 0,9        | 3,0                       |
|                                                                    | 20x130                     | 130                       | 1,2                       | 1,2               | 1,2        | 3,0                       |

1) Values are valid for  $C_{cr}$  and  $C_{min}$

2) Calculation of  $V_{Rk,c}$  see Technical Report TR 054, except for shear load parallel to free edge with  $c \geq 200 \text{ mm}$ :  $V_{Rk,c,II} = V_{Rk,b}$

3) The values are valid for steel 5.6 or greater. For steel 4.6 and 4.8 multiply  $V_{Rk,b}$  by 0,8

**ESSVE Injection system ONE, ONE ICE for masonry**

**Performances clay hollow brick Porotherm Homebric**

Installation parameters (continue)

Characteristic values of resistance under tension and shear load

**Annex C 22**

**Brick type: Clay silicate hollow brick Porotherm Homebric**

**Table C55: Characteristic values of resistance under tension and shear loads (continue)**

| Anchor size                                                         | Sleeve | Effective anchorage depth  | Characteristic resistance |           |                   |                           |
|---------------------------------------------------------------------|--------|----------------------------|---------------------------|-----------|-------------------|---------------------------|
|                                                                     |        |                            | Use category              |           |                   |                           |
|                                                                     |        |                            | d/d<br>w/d<br>w/w         |           |                   | d/d<br>w/d<br>w/w         |
|                                                                     |        |                            | 40°C/24°C                 | 80°C/50°C | 120°C/72°C        | For all temperature range |
| $h_{ef}$                                                            |        | $N_{Rk,b} = N_{Rk,p}^{1)}$ |                           |           | $V_{Rk,b}^{2)3)}$ |                           |
| [mm]                                                                |        | [kN]                       |                           |           |                   |                           |
| <b>Compressive strength <math>f_b \geq 10 \text{ N/mm}^2</math></b> |        |                            |                           |           |                   |                           |
| M8                                                                  | 12x80  | 80                         | 1,2                       | 1,2       | 1,2               | 3,0                       |
| M8 / M10/ IG-M6                                                     | 16x85  | 85                         | 1,2                       | 1,2       | 1,2               | 3,0                       |
|                                                                     | 16x130 | 130                        | 1,5                       | 1,5       | 1,5               | 3,5                       |
| M12 / M16 / IG-M8 / IG-M10                                          | 20x85  | 85                         | 1,2                       | 1,2       | 1,2               | 4,0                       |
|                                                                     | 20x130 | 130                        | 1,5                       | 1,5       | 1,5               | 4,0                       |

1) Values are valid for  $c_{cr}$  and  $c_{min}$

2) Calculation of  $V_{Rk,c}$  see Technical Report TR 054, except for shear load parallel to free edge with  $c \geq 200 \text{ mm}$ :  $V_{Rk,c,II} = V_{Rk,b}$

3) The values are valid for steel 5.6 or greater. For steel 4.6 and 4.8 multiply  $V_{Rk,b}$  by 0,8

**Table C56: Displacements**

| Anchor size                | Sleeve | Effective anchorage depth $h_{ef}$ | N    | $\delta_N / N$ | $\delta_{N0}$ | $\delta_{N\infty}$ | V    | $\delta_{V0}$ | $\delta_{V\infty}$ |
|----------------------------|--------|------------------------------------|------|----------------|---------------|--------------------|------|---------------|--------------------|
|                            |        |                                    | [kN] | [mm/kN]        | [mm]          | [mm]               | [kN] | [mm]          | [mm]               |
| M8                         | 12x80  | 80                                 | 0,34 | 0,80           | 0,27          | 0,55               | 0,9  | 1,20          | 1,80               |
| M8 / M10/ IG-M6            | 16x85  | 85                                 |      |                |               |                    | 0,9  |               |                    |
|                            | 16x130 | 130                                | 0,43 |                | 0,34          | 0,69               | 1,0  |               |                    |
| M12 / M16 / IG-M8 / IG-M10 | 20x85  | 85                                 | 0,34 |                | 0,27          | 0,55               | 1,14 |               |                    |
|                            | 20x130 | 130                                | 0,43 |                | 0,34          | 0,69               |      |               |                    |

**ESSVE Injection system ONE, ONE ICE for masonry**

**Performances clay hollow brick Porotherm Homebric**

Characteristic values of resistance under tension and shear load (continue)

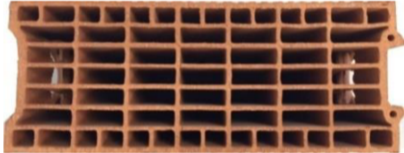
Displacements

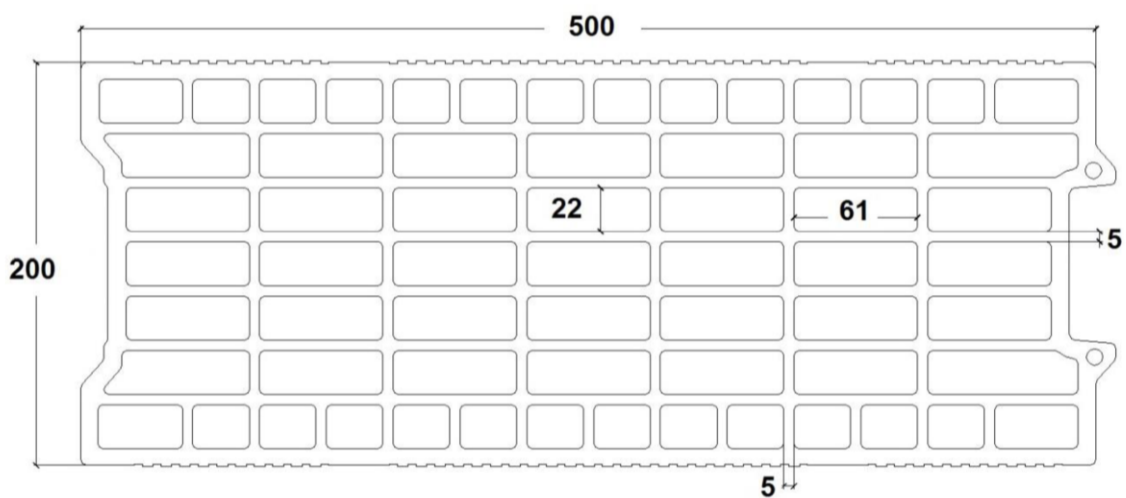
**Annex C 23**



**Brick type: Clay hollow brick BGV Thermo**

**Table C57: Description of the brick**

|                                                      |                                 |                                                                                     |
|------------------------------------------------------|---------------------------------|-------------------------------------------------------------------------------------|
| Brick type                                           | Clay hollow brick<br>BGV Thermo |  |
| Bulk density $\rho$ [kg/dm <sup>3</sup> ]            | 0,6                             |                                                                                     |
| Compressive strength $f_b \geq$ [N/mm <sup>2</sup> ] | 4, 6 or 10                      |                                                                                     |
| Code                                                 | EN 771-1                        |                                                                                     |
| Producer (country code)                              | e.g. Leroux (FR)                |                                                                                     |
| Brick dimensions [mm]                                | 500 x 200 x 314                 |                                                                                     |
| Drilling method                                      | Rotary                          |                                                                                     |



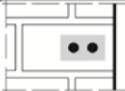
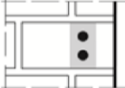
**Table C58: Installation parameters**

| Anchor size           |                         | [-]  | All sizes               |
|-----------------------|-------------------------|------|-------------------------|
| Edge distance         | $C_{cr}$                | [mm] | 100 (120) <sup>1)</sup> |
| Minimum edge distance | $C_{min}$ <sup>2)</sup> | [mm] | 100 (120) <sup>1)</sup> |
| Spacing               | $S_{cr,II}$             | [mm] | 500                     |
|                       | $S_{cr,\perp}$          | [mm] | 314                     |
| Minimum spacing       | $S_{min}$               | [mm] | 100                     |

<sup>1)</sup> Value in brackets for SH20x85 and SH20x130

<sup>2)</sup> For  $V_{Rk,c}$ :  $C_{min}$  according to Technical Report TR 054

**Table C59: Group factor for anchor group in case of tension loading**

| Configuration                                       |                                                                                     | with $c \geq$ | with $s \geq$ |                      |     |     |
|-----------------------------------------------------|-------------------------------------------------------------------------------------|---------------|---------------|----------------------|-----|-----|
| II: anchors placed parallel to horizontal joint     |  | 200           | 100           | $\alpha_{g,N,II}$    | [-] | 1,7 |
|                                                     |                                                                                     | $C_{cr}$      | 500           |                      |     | 2,0 |
| ⊥: anchors placed perpendicular to horizontal joint |  | 200           | 100           | $\alpha_{g,N,\perp}$ |     | 1,1 |
|                                                     |                                                                                     | $C_{cr}$      | 314           |                      |     | 2,0 |

**ESSVE Injection system ONE, ONE ICE for masonry**

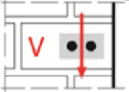
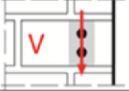
**Performances clay hollow brick BGV Thermo**

Description of the brick  
Installation parameters

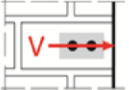
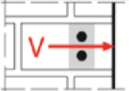
**Annex C 24**

**Brick type: Clay hollow brick BGV Thermo**

**Table C60: Group factor for anchor group in case of shear loading parallel to free edge**

| Configuration                                       |                                                                                   | with $c \geq$ | with $s \geq$ |                      |     |     |
|-----------------------------------------------------|-----------------------------------------------------------------------------------|---------------|---------------|----------------------|-----|-----|
| : anchors placed parallel to horizontal joint       |  | $C_{cr}$      | 500           | $\alpha_{g,V,  }$    | [-] | 2,0 |
| ⊥: anchors placed perpendicular to horizontal joint |  | $C_{cr}$      | 314           | $\alpha_{g,V,\perp}$ |     | 2,0 |

**Table C61: Group factor for anchor group in case of shear loading perpendicular to free edge**

| Configuration                                       |                                                                                   | with $c \geq$ | with $s \geq$ |                      |     |     |
|-----------------------------------------------------|-----------------------------------------------------------------------------------|---------------|---------------|----------------------|-----|-----|
| : anchors placed parallel to horizontal joint       |  | $C_{cr}$      | 500           | $\alpha_{g,V,  }$    | [-] | 2,0 |
| ⊥: anchors placed perpendicular to horizontal joint |  | $C_{cr}$      | 314           | $\alpha_{g,V,\perp}$ |     | 2,0 |

**ESSVE Injection system ONE, ONE ICE for masonry**

**Performances clay hollow brick BGV Thermo**  
Installation parameters (continue)

**Annex C 25**

**Brick type: Clay hollow brick BGV Thermo**

**Table C62: Characteristic values of resistance under tension and shear loads**

| Anchor size                                                         | Sleeve | Effective anchorage depth  | Characteristic resistance |           |                   |                           |
|---------------------------------------------------------------------|--------|----------------------------|---------------------------|-----------|-------------------|---------------------------|
|                                                                     |        |                            | Use category              |           |                   |                           |
|                                                                     |        |                            | d/d<br>w/d<br>w/w         |           |                   | d/d<br>w/d<br>w/w         |
|                                                                     |        |                            | 40°C/24°C                 | 80°C/50°C | 120°C/72°C        | For all temperature range |
| $h_{ef}$                                                            |        | $N_{Rk,b} = N_{Rk,p}^{1)}$ |                           |           | $V_{Rk,b}^{2)3)}$ |                           |
| [mm]                                                                |        | [kN]                       |                           |           |                   |                           |
| <b>Compressive strength <math>f_b \geq 4 \text{ N/mm}^2</math></b>  |        |                            |                           |           |                   |                           |
| M8                                                                  | 12x80  | 80                         | 0,6                       | 0,6       | 0,6               | 2,0                       |
| M8 / M10/<br>IG-M6                                                  | 16x85  | 85                         | 0,6                       | 0,6       | 0,6               | 2,0                       |
|                                                                     | 16x130 | 130                        | 1,2                       | 1,2       | 0,9               | 2,5                       |
| M12 / M16 /<br>IG-M8 /<br>IG-M10                                    | 20x85  | 85                         | 0,6                       | 0,6       | 0,6               | 2,5                       |
|                                                                     | 20x130 | 130                        | 1,2                       | 1,2       | 0,9               | 2,5                       |
| <b>Compressive strength <math>f_b \geq 6 \text{ N/mm}^2</math></b>  |        |                            |                           |           |                   |                           |
| M8                                                                  | 12x80  | 80                         | 0,9                       | 0,9       | 0,75              | 2,5                       |
| M8 / M10/<br>IG-M6                                                  | 16x85  | 85                         | 0,9                       | 0,9       | 0,75              | 2,5                       |
|                                                                     | 16x130 | 130                        | 1,5                       | 1,5       | 1,2               | 3,0                       |
| M12 / M16 /<br>IG-M8 /<br>IG-M10                                    | 20x85  | 85                         | 0,9                       | 0,9       | 0,75              | 3,0                       |
|                                                                     | 20x130 | 130                        | 1,5                       | 1,5       | 1,2               | 3,0                       |
| <b>Compressive strength <math>f_b \geq 10 \text{ N/mm}^2</math></b> |        |                            |                           |           |                   |                           |
| M8                                                                  | 12x80  | 80                         | 0,9                       | 0,9       | 0,9               | 3,5                       |
| M8 / M10/<br>IG-M6                                                  | 16x85  | 85                         | 0,9                       | 0,9       | 0,9               | 3,5                       |
|                                                                     | 16x130 | 130                        | 2,0                       | 2,0       | 1,5               | 4,0                       |
| M12 / M16 /<br>IG-M8 /<br>IG-M10                                    | 20x85  | 85                         | 0,9                       | 0,9       | 0,9               | 4,0                       |
|                                                                     | 20x130 | 130                        | 2,0                       | 2,0       | 1,5               | 4,0                       |

1) Values are valid for  $c_{cr}$  and  $c_{min}$

2) Calculation of  $V_{Rk,c}$  see Technical Report TR 054, except for shear load parallel to free edge with  $c \geq 250 \text{ mm}$ :  $V_{Rk,c,II} = V_{Rk,b}$

3) The values are valid for steel 5.6 or greater. For steel 4.6 and 4.8 multiply  $V_{Rk,b}$  by 0,8

**Table C63: Displacements**

| Anchor size                      | Sleeve | Effective anchorage depth $h_{ef}$ | N    | $\delta_N / N$ | $\delta_{N0}$ | $\delta_{N\infty}$ | V   | $\delta_{V0}$ | $\delta_{V\infty}$ |
|----------------------------------|--------|------------------------------------|------|----------------|---------------|--------------------|-----|---------------|--------------------|
|                                  |        |                                    |      |                |               |                    |     |               |                    |
| M8                               | 12x80  | 80                                 | 0,26 | 0,80           | 0,21          | 0,41               | 0,7 | 1,00          | 1,50               |
| M8 / M10/<br>IG-M6               | 16x85  | 85                                 |      |                |               |                    |     |               |                    |
|                                  | 16x130 | 130                                | 0,34 |                | 0,69          |                    |     |               |                    |
| M12 / M16 /<br>IG-M8 /<br>IG-M10 | 20x85  | 85                                 | 0,21 |                | 0,41          |                    |     |               |                    |
|                                  | 20x130 | 130                                | 0,34 | 0,69           |               |                    |     |               |                    |

**ESSVE Injection system ONE, ONE ICE for masonry**


**Performances clay hollow brick BGV Thermo**

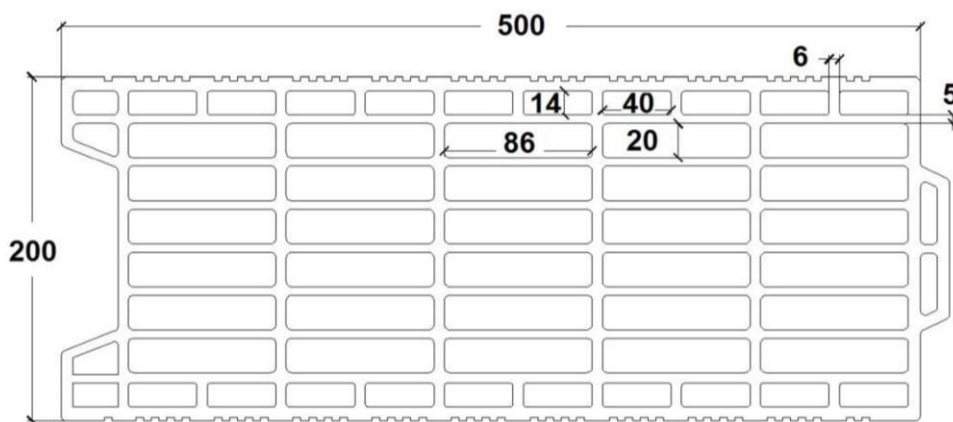
Characteristic values of resistance under tension and shear load  
Displacements

**Annex C 26**

**Brick type: Clay hollow brick Calibric R+**

**Table C64: Description of the brick**

|                                                      |                                  |                                                                                     |
|------------------------------------------------------|----------------------------------|-------------------------------------------------------------------------------------|
| Brick type                                           | Clay hollow brick<br>Calibric R+ |  |
| Bulk density $\rho$ [kg/dm <sup>3</sup> ]            | 0,6                              |                                                                                     |
| Compressive strength $f_b \geq$ [N/mm <sup>2</sup> ] | 6, 9 or 12                       |                                                                                     |
| Code                                                 | EN 771-1                         |                                                                                     |
| Producer (country code)                              | e.g. Terreal (FR)                |                                                                                     |
| Brick dimensions [mm]                                | 500 x 200 x 314                  |                                                                                     |
| Drilling method                                      | Rotary                           |                                                                                     |



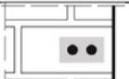
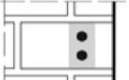
**Table C65: Installation parameters**

|                       |                         |      |                         |
|-----------------------|-------------------------|------|-------------------------|
| Anchor size           |                         | [-]  | All sizes               |
| Edge distance         | $C_{cr}$                | [mm] | 100 (120) <sup>1)</sup> |
| Minimum edge distance | $C_{min}$ <sup>2)</sup> | [mm] | 100 (120) <sup>1)</sup> |
| Spacing               | $S_{cr,II}$             | [mm] | 500                     |
|                       | $S_{cr,L}$              | [mm] | 314                     |
| Minimum spacing       | $S_{min}$               | [mm] | 100                     |

<sup>1)</sup> Value in brackets for SH20x85 and SH20x130

<sup>2)</sup> For  $V_{Rk,c}$ :  $C_{min}$  according to Technical Report TR 054

**Table C66: Group factor for anchor group in case of tension loading**

| Configuration                                       |                                                                                     | with $c \geq$ | with $s \geq$ |                   |     |     |
|-----------------------------------------------------|-------------------------------------------------------------------------------------|---------------|---------------|-------------------|-----|-----|
| II: anchors placed parallel to horizontal joint     |  | 175           | 100           | $\alpha_{g,N,II}$ | [-] | 1,7 |
|                                                     |                                                                                     | $C_{cr}$      | 500           |                   |     | 2,0 |
| L: anchors placed perpendicular to horizontal joint |  | 175           | 100           | $\alpha_{g,N,L}$  | [-] | 1,0 |
|                                                     |                                                                                     | $C_{cr}$      | 314           |                   |     | 2,0 |

**ESSVE Injection system ONE, ONE ICE for masonry**

**Performances clay hollow brick Calibric R+**

Description of the brick  
Installation parameters

**Annex C 27**

**Brick type: Clay hollow brick Calibric R+**

**Table C67: Group factor for anchor group in case of shear loading parallel to free edge**

| Configuration                                       |  | with $c \geq$ | with $s \geq$ |                      |     |     |
|-----------------------------------------------------|--|---------------|---------------|----------------------|-----|-----|
| II: anchors placed parallel to horizontal joint     |  | $C_{cr}$      | 500           | $\alpha_{g,V,II}$    | [-] | 2,0 |
| ⊥: anchors placed perpendicular to horizontal joint |  | $C_{cr}$      | 314           | $\alpha_{g,V,\perp}$ |     | 2,0 |

**Table C68: Group factor for anchor group in case of shear loading perpendicular to free edge**

| Configuration                                       |  | with $c \geq$ | with $s \geq$ |                      |     |     |
|-----------------------------------------------------|--|---------------|---------------|----------------------|-----|-----|
| II: anchors placed parallel to horizontal joint     |  | $C_{cr}$      | 500           | $\alpha_{g,V,II}$    | [-] | 2,0 |
| ⊥: anchors placed perpendicular to horizontal joint |  | $C_{cr}$      | 314           | $\alpha_{g,V,\perp}$ |     | 2,0 |

**Table C69: Characteristic values of resistance under tension and shear loads**

| Anchor size                                                        | Sleeve | Effective anchorage depth | Characteristic resistance  |           |            |                           |
|--------------------------------------------------------------------|--------|---------------------------|----------------------------|-----------|------------|---------------------------|
|                                                                    |        |                           | Use category               |           |            |                           |
|                                                                    |        |                           | d/d<br>w/d<br>w/w          |           |            | d/d<br>w/d<br>w/w         |
|                                                                    |        |                           | 40°C/24°C                  | 80°C/50°C | 120°C/72°C | For all temperature range |
|                                                                    |        | $h_{ef}$                  | $N_{RK,b} = N_{RK,p}^{1)}$ |           |            | $V_{RK,b}^{2)3)}$         |
|                                                                    |        | [mm]                      | [kN]                       |           |            |                           |
| <b>Compressive strength <math>f_b \geq 6 \text{ N/mm}^2</math></b> |        |                           |                            |           |            |                           |
| M8                                                                 | 12x80  | 80                        | 0,9                        | 0,9       | 0,75       | 3,0                       |
| M8 / M10/<br>IG-M6                                                 | 16x85  | 85                        | 0,9                        | 0,9       | 0,75       | 4,0                       |
|                                                                    | 16x130 | 130                       | 1,2                        | 1,2       | 0,9        | 4,0                       |
| M12 / M16 /<br>IG-M8 /<br>IG-M10                                   | 20x85  | 85                        | 0,9                        | 0,9       | 0,75       | 6,0                       |
|                                                                    | 20x130 | 130                       | 1,2                        | 1,2       | 0,9        | 6,0                       |
| <b>Compressive strength <math>f_b \geq 9 \text{ N/mm}^2</math></b> |        |                           |                            |           |            |                           |
| M8                                                                 | 12x80  | 80                        | 1,2                        | 1,2       | 0,9        | 3,5                       |
| M8 / M10/<br>IG-M6                                                 | 16x85  | 85                        | 1,2                        | 1,2       | 0,9        | 5,0                       |
|                                                                    | 16x130 | 130                       | 1,5                        | 1,5       | 1,2        | 5,0                       |
| M12 / M16 /<br>IG-M8 /<br>IG-M10                                   | 20x85  | 85                        | 1,2                        | 1,2       | 0,9        | 7,5                       |
|                                                                    | 20x130 | 130                       | 1,5                        | 1,5       | 1,2        | 7,5                       |

1) Values are valid for  $c_{cr}$  and  $c_{min}$

2) Calculation of  $V_{RK,c}$  see Technical Report TR 054, except for shear load parallel to free edge with  $c \geq 250 \text{ mm}$ :  $V_{RK,c,II} = V_{RK,b}$

3) The values are valid for steel 5.6 or greater. For steel 4.6 and 4.8 multiply  $V_{RK,b}$  by 0,8

**ESSVE Injection system ONE, ONE ICE for masonry**

**Performances clay hollow brick Calibric R+**

Installation parameters (continue)

Characteristic values of resistance under tension and shear load

**Annex C 28**

**Brick type: Clay hollow brick Calibric R+**

**Table C70: Characteristic values of resistance under tension and shear loads (continue)**

| Anchor size                                                         | Sleeve | Effective anchorage depth  | Characteristic resistance |           |                   |                           |
|---------------------------------------------------------------------|--------|----------------------------|---------------------------|-----------|-------------------|---------------------------|
|                                                                     |        |                            | Use category              |           |                   |                           |
|                                                                     |        |                            | d/d<br>w/d<br>w/w         |           |                   | d/d<br>w/d<br>w/w         |
|                                                                     |        |                            | 40°C/24°C                 | 80°C/50°C | 120°C/72°C        | For all temperature range |
| $h_{ef}$                                                            |        | $N_{Rk,b} = N_{Rk,p}^{1)}$ |                           |           | $V_{Rk,b}^{2)3)}$ |                           |
| [mm]                                                                |        | [kN]                       |                           |           |                   |                           |
| <b>Compressive strength <math>f_b \geq 12 \text{ N/mm}^2</math></b> |        |                            |                           |           |                   |                           |
| M8                                                                  | 12x80  | 80                         | 1,2                       | 1,2       | 0,9               | 4,0                       |
| M8 / M10/<br>IG-M6                                                  | 16x85  | 85                         | 1,2                       | 1,2       | 0,9               | 5,5                       |
|                                                                     | 16x130 | 130                        | 1,5                       | 1,5       | 1,2               | 5,5                       |
| M12 / M16 /<br>IG-M8 /<br>IG-M10                                    | 20x85  | 85                         | 1,2                       | 1,2       | 0,9               | 8,5                       |
|                                                                     | 20x130 | 130                        | 1,5                       | 1,5       | 1,2               | 8,5                       |

1) Values are valid for  $c_{cr}$  and  $c_{min}$

2) Calculation of  $V_{Rk,c}$  see Technical Report TR 054, except for shear load parallel to free edge with  $c \geq 250 \text{ mm}$ :  $V_{Rk,c,II} = V_{Rk,b}$

3) The values are valid for steel 5.6 or greater. For steel 4.6 and 4.8 multiply  $V_{Rk,b}$  by 0,8

**Table C71: Displacements**

| Anchor size                      | Sleeve | Effective anchorage depth $h_{ef}$ | N    | $\delta_N / N$ | $\delta_{N0}$ | $\delta_{N\infty}$ | V    | $\delta_{V0}$ | $\delta_{V\infty}$ |
|----------------------------------|--------|------------------------------------|------|----------------|---------------|--------------------|------|---------------|--------------------|
|                                  |        |                                    |      |                |               |                    |      |               |                    |
| M8                               | 12x80  | 80                                 | 0,34 | 0,80           | 0,27          | 0,55               | 1,0  | 1,10          | 1,65               |
| M8 / M10/<br>IG-M6               | 16x85  | 85                                 |      |                |               |                    |      |               |                    |
|                                  |        | 16x130                             | 130  | 0,43           | 0,34          | 0,69               | 1,43 | 2,00          | 3,00               |
| M12 / M16 /<br>IG-M8 /<br>IG-M10 | 20x85  | 85                                 | 0,34 | 0,27           | 0,55          | 2,14               |      |               |                    |
|                                  |        | 20x130                             | 130  | 0,43           | 0,34          |                    | 0,69 |               |                    |

**ESSVE Injection system ONE, ONE ICE for masonry**


**Performances clay hollow brick Calibric R+**

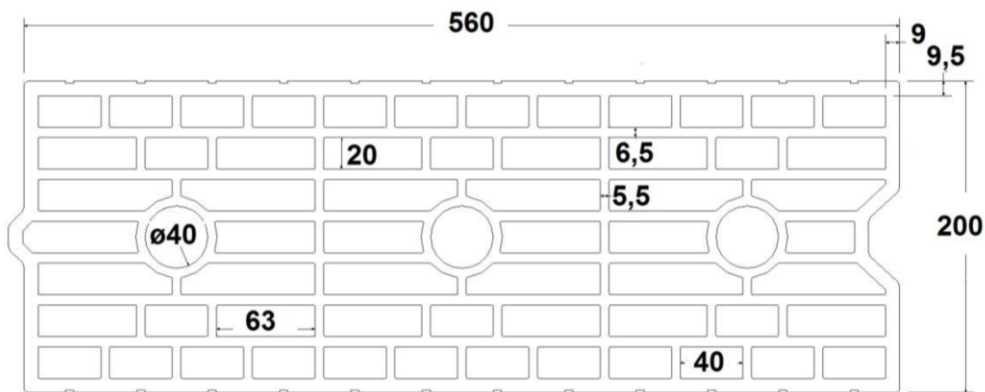
Characteristic values of resistance under tension and shear load (continue)  
Displacements

**Annex C 29**

**Brick type: Clay hollow brick Urbanbric**

**Table C72: Description of the brick**

|                                                      |                                |                                                                                     |
|------------------------------------------------------|--------------------------------|-------------------------------------------------------------------------------------|
| Brick type                                           | Clay hollow brick<br>Urbanbric |  |
| Bulk density $\rho$ [kg/dm <sup>3</sup> ]            | 0,7                            |                                                                                     |
| Compressive strength $f_b \geq$ [N/mm <sup>2</sup> ] | 6, 9 or 12                     |                                                                                     |
| Code                                                 | EN 771-1                       |                                                                                     |
| Producer (country code)                              | e.g. Imerys (FR)               |                                                                                     |
| Brick dimensions [mm]                                | 560 x 200 x 274                |                                                                                     |
| Drilling method                                      | Rotary                         |                                                                                     |




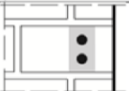
**Table C73: Installation parameters**

|                       |                         |      |                         |
|-----------------------|-------------------------|------|-------------------------|
| Anchor size           |                         | [-]  | All sizes               |
| Edge distance         | $C_{cr}$                | [mm] | 100 (120) <sup>1)</sup> |
| Minimum edge distance | $C_{min}$ <sup>2)</sup> | [mm] | 100 (120) <sup>1)</sup> |
| Spacing               | $S_{cr,II}$             | [mm] | 560                     |
|                       | $S_{cr,\perp}$          | [mm] | 274                     |
| Minimum spacing       | $S_{min}$               | [mm] | 100                     |

<sup>1)</sup> Value in brackets for SH20x85 and SH20x130

<sup>2)</sup> For  $V_{Rk,c}$ :  $C_{min}$  according to Technical Report TR 054

**Table C74: Group factor for anchor group in case of tension loading**

| Configuration                                       |                                                                                     | with $c \geq$ | with $s \geq$ |                      |     |     |
|-----------------------------------------------------|-------------------------------------------------------------------------------------|---------------|---------------|----------------------|-----|-----|
| II: anchors placed parallel to horizontal joint     |  | 185           | 100           | $\alpha_{g,N,II}$    | [-] | 1,9 |
|                                                     |                                                                                     | $C_{cr}$      | 560           |                      |     | 2,0 |
| ⊥: anchors placed perpendicular to horizontal joint |  | 185           | 100           | $\alpha_{g,N,\perp}$ |     | 1,1 |
|                                                     |                                                                                     | $C_{cr}$      | 274           |                      |     | 2,0 |

**ESSVE Injection system ONE, ONE ICE for masonry**

**Performances clay hollow brick Urbanbric**

Description of the brick  
Installation parameters

**Annex C 30**

**Brick type: Clay hollow brick Urbanbric**

**Table C75: Group factor for anchor group in case of shear loading parallel to free edge**

| Configuration                                       |  | with $c \geq$ | with $s \geq$ |                   |     |     |
|-----------------------------------------------------|--|---------------|---------------|-------------------|-----|-----|
| II: anchors placed parallel to horizontal joint     |  | $C_{cr}$      | 560           | $\alpha_{g,V,II}$ | [-] | 2,0 |
| I: anchors placed perpendicular to horizontal joint |  | $C_{cr}$      | 274           | $\alpha_{g,V,I}$  |     | 2,0 |

**Table C76: Group factor for anchor group in case of shear loading perpendicular to free edge**

| Configuration                                       |  | with $c \geq$ | with $s \geq$ |                   |     |     |
|-----------------------------------------------------|--|---------------|---------------|-------------------|-----|-----|
| II: anchors placed parallel to horizontal joint     |  | $C_{cr}$      | 560           | $\alpha_{g,V,II}$ | [-] | 2,0 |
| I: anchors placed perpendicular to horizontal joint |  | $C_{cr}$      | 274           | $\alpha_{g,V,I}$  |     | 2,0 |

**Table C77: Characteristic values of resistance under tension and shear loads**

| Anchor size                                                        | Sleeve | Effective anchorage depth | Characteristic resistance  |           |            |                           |
|--------------------------------------------------------------------|--------|---------------------------|----------------------------|-----------|------------|---------------------------|
|                                                                    |        |                           | Use category               |           |            |                           |
|                                                                    |        |                           | d/d<br>w/d<br>w/w          |           |            | d/d<br>w/d<br>w/w         |
|                                                                    |        |                           | 40°C/24°C                  | 80°C/50°C | 120°C/72°C | For all temperature range |
|                                                                    |        | $h_{ef}$                  | $N_{Rk,b} = N_{Rk,p}^{1)}$ |           |            | $V_{Rk,b}^{2)3)}$         |
|                                                                    |        | [mm]                      | [kN]                       |           |            |                           |
| <b>Compressive strength <math>f_b \geq 6 \text{ N/mm}^2</math></b> |        |                           |                            |           |            |                           |
| M8                                                                 | 12x80  | 80                        | 0,9                        | 0,9       | 0,75       | 3,0                       |
| M8 / M10/<br>IG-M6                                                 | 16x85  | 85                        | 0,9                        | 0,9       | 0,75       | 3,0                       |
|                                                                    | 16x130 | 130                       | 2,0                        | 2,0       | 1,5        | 3,0                       |
| M12 / M16 /<br>IG-M8 / IG-M10                                      | 20x85  | 85                        | 0,9                        | 0,9       | 0,75       | 3,5                       |
|                                                                    | 20x130 | 130                       | 2,0                        | 2,0       | 1,5        | 3,5                       |
| <b>Compressive strength <math>f_b \geq 9 \text{ N/mm}^2</math></b> |        |                           |                            |           |            |                           |
| M8                                                                 | 12x80  | 80                        | 0,9                        | 0,9       | 0,9        | 4,0                       |
| M8 / M10/<br>IG-M6                                                 | 16x85  | 85                        | 0,9                        | 0,9       | 0,9        | 4,0                       |
|                                                                    | 16x130 | 130                       | 2,5                        | 2,5       | 2,0        | 4,0                       |
| M12 / M16 /<br>IG-M8 / IG-M10                                      | 20x85  | 85                        | 0,9                        | 0,9       | 0,9        | 4,5                       |
|                                                                    | 20x130 | 130                       | 2,5                        | 2,5       | 2,0        | 4,5                       |

1) Values are valid for  $C_{cr}$  and  $C_{min}$

2) Calculation of  $V_{Rk,c}$  see Technical Report TR 054, except for shear load parallel to free edge with  $c \geq 190 \text{ mm}$ :  $V_{Rk,c,II} = V_{Rk,b}$

3) The values are valid for steel 5.6 or greater. For steel 4.6 and 4.8 multiply  $V_{Rk,b}$  by 0,8

**ESSVE Injection system ONE, ONE ICE for masonry**

**Performances clay hollow brick Urbanbric**

Installation parameters (continue)

Characteristic values of resistance under tension and shear load

**Annex C 31**



**Brick type: Clay hollow brick Urbanbric**

**Table C78: Characteristic values of resistance under tension and shear loads (continue)**

| Anchor size                                                         | Sleeve | Effective anchorage depth  | Characteristic resistance |           |                   |                           |
|---------------------------------------------------------------------|--------|----------------------------|---------------------------|-----------|-------------------|---------------------------|
|                                                                     |        |                            | Use category              |           |                   |                           |
|                                                                     |        |                            | d/d<br>w/d<br>w/w         |           |                   | d/d<br>w/d<br>w/w         |
|                                                                     |        |                            | 40°C/24°C                 | 80°C/50°C | 120°C/72°C        | For all temperature range |
| $h_{ef}$                                                            |        | $N_{Rk,b} = N_{Rk,p}^{1)}$ |                           |           | $V_{Rk,b}^{2)3)}$ |                           |
| [mm]                                                                |        | [kN]                       |                           |           |                   |                           |
| <b>Compressive strength <math>f_b \geq 12 \text{ N/mm}^2</math></b> |        |                            |                           |           |                   |                           |
| M8                                                                  | 12x80  | 80                         | 1,2                       | 1,2       | 0,9               | 4,5                       |
| M8 / M10/<br>IG-M6                                                  | 16x85  | 85                         | 1,2                       | 1,2       | 0,9               | 4,5                       |
|                                                                     | 16x130 | 130                        | 3,0                       | 3,0       | 2,5               | 4,5                       |
| M12 / M16 /<br>IG-M8 / IG-M10                                       | 20x85  | 85                         | 1,2                       | 1,2       | 0,9               | 5,0                       |
|                                                                     | 20x130 | 130                        | 3,0                       | 3,0       | 2,5               | 5,0                       |

1) Values are valid for  $c_{cr}$  and  $c_{min}$

2) Calculation of  $V_{Rk,c}$  see Technical Report TR 054, except for shear load parallel to free edge with  $c \geq 190 \text{ mm}$ :  $V_{Rk,c,II} = V_{Rk,b}$

3) The values are valid for steel 5.6 or greater. For steel 4.6 and 4.8 multiply  $V_{Rk,b}$  by 0,8

**Table C79: Displacements**

| Anchor size                      | Sleeve | Effective anchorage depth $h_{ef}$ | N    | $\delta_N / N$ | $\delta_{N0}$ | $\delta_{N\infty}$ | V    | $\delta_{V0}$ | $\delta_{V\infty}$ |
|----------------------------------|--------|------------------------------------|------|----------------|---------------|--------------------|------|---------------|--------------------|
|                                  |        | [mm]                               | [kN] | [mm/kN]        | [mm]          | [mm]               | [kN] | [mm]          | [mm]               |
| M8                               | 12x80  | 80                                 | 0,34 | 0,80           | 0,27          | 0,55               | 1,30 | 1,00          | 1,50               |
| M8 / M10/<br>IG-M6               | 16x85  | 85                                 |      |                |               |                    |      |               |                    |
|                                  | 16x130 | 130                                | 0,86 |                |               |                    |      |               |                    |
| M12 / M16 /<br>IG-M8 /<br>IG-M10 | 20x85  | 85                                 | 0,34 |                | 0,27          | 0,55               | 1,43 |               |                    |
|                                  | 20x130 | 130                                | 0,86 |                | 0,69          | 1,37               |      |               |                    |

**ESSVE Injection system ONE, ONE ICE for masonry**


**Performances clay hollow brick Urbanbric**

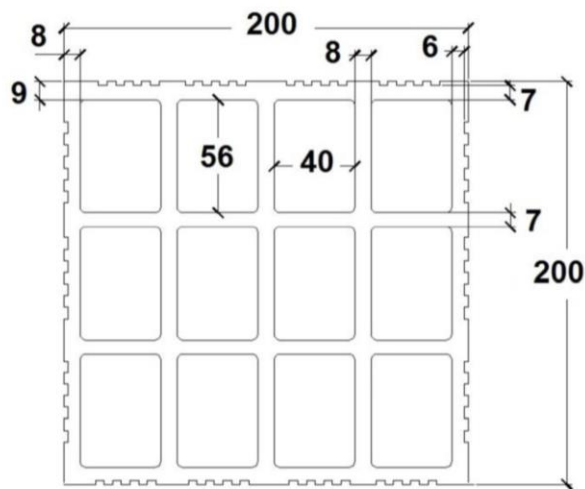
Characteristic values of resistance under tension and shear load (continue)  
Displacements

**Annex C 32**

**Brick type: Clay hollow brick Brique creuse C40**

**Table C80: Description of the brick**

|                                                      |                                        |                                                                                     |
|------------------------------------------------------|----------------------------------------|-------------------------------------------------------------------------------------|
| Brick type                                           | Clay hollow brick<br>Brique creuse C40 |  |
| Bulk density $\rho$ [kg/dm <sup>3</sup> ]            | 0,7                                    |                                                                                     |
| Compressive strength $f_b \geq$ [N/mm <sup>2</sup> ] | 4, 8 or 12                             |                                                                                     |
| Code                                                 | EN 771-1                               |                                                                                     |
| Producer (country code)                              | e.g. Terreal (FR)                      |                                                                                     |
| Brick dimensions [mm]                                | 500 x 200 x 200                        |                                                                                     |
| Drilling method                                      | Rotary                                 |                                                                                     |



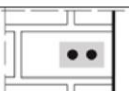
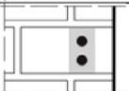
**Table C81: Installation parameters**

| Anchor size           |                         | [-]  | All sizes               |
|-----------------------|-------------------------|------|-------------------------|
| Edge distance         | $C_{cr}$                | [mm] | 100 (120) <sup>1)</sup> |
| Minimum edge distance | $C_{min}$ <sup>2)</sup> | [mm] | 100 (120) <sup>1)</sup> |
| Spacing               | $S_{cr,II}$             | [mm] | 500                     |
|                       | $S_{cr,\perp}$          | [mm] | 200                     |
| Minimum spacing       | $S_{min}$               | [mm] | 200                     |

<sup>1)</sup> Value in brackets for SH20x85 and SH20x130

<sup>2)</sup> For  $V_{Rk,c}$ :  $C_{min}$  according to Technical Report TR 054

**Table C82: Group factor for anchor group in case of tension loading**

| Configuration                                              |                                                                                     | with $c \geq$ | with $s \geq$ |                      |     |     |
|------------------------------------------------------------|-------------------------------------------------------------------------------------|---------------|---------------|----------------------|-----|-----|
| II: anchors placed parallel to horizontal joint            |  | $C_{cr}$      | 200           | $\alpha_{g,N,II}$    | [-] | 2,0 |
| $\perp$ : anchors placed perpendicular to horizontal joint |  | $C_{cr}$      | 200           | $\alpha_{g,N,\perp}$ |     | 2,0 |

**ESSVE Injection system ONE, ONE ICE for masonry**

**Performances clay hollow brick Brique creuse C40**

Description of the brick  
Installation parameters

**Annex C 33**

**Brick type: Clay hollow brick Brique creuse C40**

**Table C83: Group factor for anchor group in case of shear loading parallel to free edge**

| Configuration                                       |  | with $c \geq$ | with $s \geq$ |                   |     |     |
|-----------------------------------------------------|--|---------------|---------------|-------------------|-----|-----|
| II: anchors placed parallel to horizontal joint     |  | $C_{cr}$      | 500           | $\alpha_{g,V,II}$ | [-] | 2,0 |
| I: anchors placed perpendicular to horizontal joint |  | $C_{cr}$      | 200           | $\alpha_{g,V,I}$  |     | 2,0 |

**Table C84: Group factor for anchor group in case of shear loading perpendicular to free edge**

| Configuration                                       |  | with $c \geq$ | with $s \geq$ |                   |     |     |
|-----------------------------------------------------|--|---------------|---------------|-------------------|-----|-----|
| II: anchors placed parallel to horizontal joint     |  | $C_{cr}$      | 500           | $\alpha_{g,V,II}$ | [-] | 2,0 |
| I: anchors placed perpendicular to horizontal joint |  | $C_{cr}$      | 200           | $\alpha_{g,V,I}$  |     | 2,0 |

**Table C85: Characteristic values of resistance under tension and shear loads**

| Anchor size                                                        | Sleeve | Effective anchorage depth | Characteristic resistance  |           |            |                           |
|--------------------------------------------------------------------|--------|---------------------------|----------------------------|-----------|------------|---------------------------|
|                                                                    |        |                           | Use category               |           |            |                           |
|                                                                    |        |                           | d/d<br>w/d<br>w/w          |           |            | d/d<br>w/d<br>w/w         |
|                                                                    |        |                           | 40°C/24°C                  | 80°C/50°C | 120°C/72°C | For all temperature range |
|                                                                    |        | $h_{ef}$                  | $N_{Rk,b} = N_{Rk,p}^{1)}$ |           |            | $V_{Rk,b}^{2)3)}$         |
|                                                                    |        | [mm]                      | [kN]                       |           |            |                           |
| <b>Compressive strength <math>f_b \geq 4 \text{ N/mm}^2</math></b> |        |                           |                            |           |            |                           |
| M8                                                                 | 12x80  | 80                        | 0,6                        | 0,6       | 0,6        | 0,9                       |
| M8 / M10/<br>IG-M6                                                 | 16x85  | 85                        | 0,6                        | 0,6       | 0,6        | 0,9                       |
|                                                                    | 16x130 | 130                       | 0,6                        | 0,6       | 0,6        | 0,9                       |
| M12 / M16 /<br>IG-M8 / IG-M10                                      | 20x85  | 85                        | 0,6                        | 0,6       | 0,6        | 0,9                       |
|                                                                    | 20x130 | 130                       | 0,6                        | 0,6       | 0,6        | 0,9                       |
| <b>Compressive strength <math>f_b \geq 8 \text{ N/mm}^2</math></b> |        |                           |                            |           |            |                           |
| M8                                                                 | 12x80  | 80                        | 0,9                        | 0,9       | 0,75       | 1,2                       |
| M8 / M10/<br>IG-M6                                                 | 16x85  | 85                        | 0,9                        | 0,9       | 0,75       | 1,2                       |
|                                                                    | 16x130 | 130                       | 0,9                        | 0,9       | 0,75       | 1,2                       |
| M12 / M16 /<br>IG-M8 / IG-M10                                      | 20x85  | 85                        | 0,9                        | 0,9       | 0,75       | 1,2                       |
|                                                                    | 20x130 | 130                       | 0,9                        | 0,9       | 0,75       | 1,2                       |

1) Values are valid for  $C_{cr}$  and  $C_{min}$

2) Calculation of  $V_{Rk,c}$  see Technical Report TR 054

3) The values are valid for steel 5.6 or greater. For steel 4.6 and 4.8 multiply  $V_{Rk,b}$  by 0,8

**ESSVE Injection system ONE, ONE ICE for masonry**

**Performances clay hollow brick Brique creuse C40**

Installation parameters (continue)

Characteristic values of resistance under tension and shear load

**Annex C 34**

**Brick type: Clay hollow brick Brique creuse C40**

**Table C86: Characteristic values of resistance under tension and shear loads (continue)**

| Anchor size                                                         | Sleeve | Effective anchorage depth  | Characteristic resistance |           |                   |                           |
|---------------------------------------------------------------------|--------|----------------------------|---------------------------|-----------|-------------------|---------------------------|
|                                                                     |        |                            | Use category              |           |                   |                           |
|                                                                     |        |                            | d/d<br>w/d<br>w/w         |           |                   | d/d<br>w/d<br>w/w         |
|                                                                     |        |                            | 40°C/24°C                 | 80°C/50°C | 120°C/72°C        | For all temperature range |
| $h_{ef}$                                                            |        | $N_{Rk,b} = N_{Rk,p}^{1)}$ |                           |           | $V_{Rk,b}^{2)3)}$ |                           |
| [mm]                                                                |        | [kN]                       |                           |           |                   |                           |
| <b>Compressive strength <math>f_b \geq 12 \text{ N/mm}^2</math></b> |        |                            |                           |           |                   |                           |
| M8                                                                  | 12x80  | 80                         | 1,2                       | 1,2       | 0,9               | 1,5                       |
| M8 / M10/<br>IG-M6                                                  | 16x85  | 85                         | 1,2                       | 1,2       | 0,9               | 1,5                       |
|                                                                     | 16x130 | 130                        | 1,2                       | 1,2       | 0,9               | 1,5                       |
| M12 / M16 /<br>IG-M8 / IG-M10                                       | 20x85  | 85                         | 1,2                       | 1,2       | 0,9               | 1,5                       |
|                                                                     | 20x130 | 130                        | 1,2                       | 1,2       | 0,9               | 1,5                       |

1) Values are valid for  $c_{cr}$  and  $c_{min}$

2) Calculation of  $V_{Rk,c}$  see Technical Report TR 054

3) The values are valid for steel 5.6 or greater. For steel 4.6 and 4.8 multiply  $V_{Rk,b}$  by 0,8

**Table C87: Displacements**

| Anchor size                      | Sleeve | Effective anchorage depth $h_{ef}$ | N    | $\delta_N / N$ | $\delta_{N0}$ | $\delta_{N\infty}$ | V   | $\delta_{V0}$ | $\delta_{V\infty}$ |
|----------------------------------|--------|------------------------------------|------|----------------|---------------|--------------------|-----|---------------|--------------------|
|                                  |        |                                    |      |                |               |                    |     |               |                    |
| M8                               | 12x80  | 80                                 | 0,17 | 0,80           | 0,14          | 0,27               | 0,3 | 0,9           | 1,35               |
| M8 / M10/<br>IG-M6               | 16x85  | 85                                 |      |                |               |                    |     |               |                    |
|                                  | 16x130 | 130                                | 0,14 |                |               |                    |     |               |                    |
| M12 / M16 /<br>IG-M8 /<br>IG-M10 | 20x85  | 85                                 | 0,17 |                |               |                    |     |               |                    |
|                                  | 20x130 | 130                                | 0,14 |                |               |                    |     |               |                    |

**ESSVE Injection system ONE, ONE ICE for masonry**


**Performances clay hollow brick Brique creuse C40**

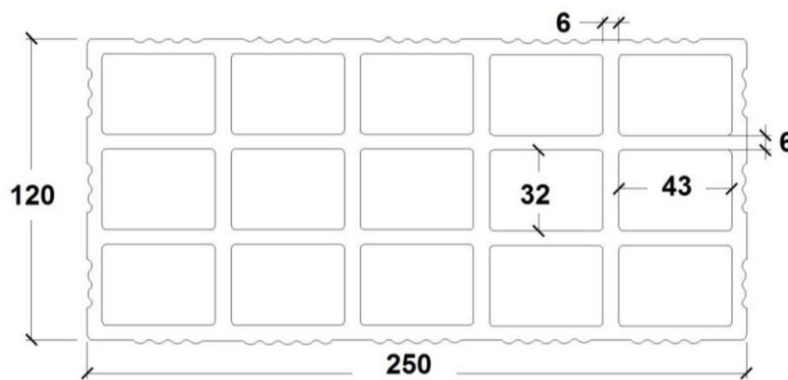
Characteristic values of resistance under tension and shear load (continue)  
Displacements

**Annex C 35**

**Brick type: Clay hollow brick Blocchi Leggeri**

**Table C88: Description of the brick**

|                                                      |                                      |                                                                                     |
|------------------------------------------------------|--------------------------------------|-------------------------------------------------------------------------------------|
| Brick type                                           | Clay hollow brick<br>Blocchi Leggeri |  |
| Bulk density $\rho$ [kg/dm <sup>3</sup> ]            | 0,6                                  |                                                                                     |
| Compressive strength $f_b \geq$ [N/mm <sup>2</sup> ] | 4, 6, 8 or 12                        |                                                                                     |
| Code                                                 | EN 771-1                             |                                                                                     |
| Producer (country code)                              | e.g. Wienerberger (IT)               |                                                                                     |
| Brick dimensions [mm]                                | 250 x 120 x 250                      |                                                                                     |
| Drilling method                                      | Rotary                               |                                                                                     |

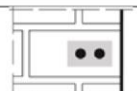
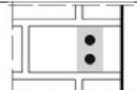


**Table C89: Installation parameters**

| Anchor size           |             | [-]  | All sizes               |
|-----------------------|-------------|------|-------------------------|
| Edge distance         | $C_{cr}$    | [mm] | 100 (120) <sup>1)</sup> |
| Minimum edge distance | $C_{min}$   | [mm] | 60                      |
| Spacing               | $S_{cr,II}$ | [mm] | 250                     |
|                       | $S_{cr,L}$  | [mm] | 120                     |
| Minimum spacing       | $S_{min}$   | [mm] | 100                     |

<sup>1)</sup> Value in brackets for SH20x85; SH20x130 and SH20x200

**Table C90: Group factor for anchor group in case of tension loading**

| Configuration                                       |                                                                                     | with $c \geq$ | with $s \geq$ |                   |     |     |
|-----------------------------------------------------|-------------------------------------------------------------------------------------|---------------|---------------|-------------------|-----|-----|
| II: anchors placed parallel to horizontal joint     |  | 60            | 100           | $\alpha_{g,N,II}$ | [-] | 1,0 |
|                                                     |                                                                                     | $C_{cr}$      | 250           |                   |     | 2,0 |
| I: anchors placed perpendicular to horizontal joint |  | 60            | 100           | $\alpha_{g,N,I}$  |     | 2,0 |

**ESSVE Injection system ONE, ONE ICE for masonry**

**Performances clay hollow brick Blocchi Leggeri**

Description of the brick  
Installation parameters

**Annex C 36**

**Brick type: Clay hollow brick Blocchi Leggeri**

**Table C91: Group factor for anchor group in case of shear loading parallel to free edge**

| Configuration                                       |  | with $c \geq$ | with $s \geq$ |                      |     |     |
|-----------------------------------------------------|--|---------------|---------------|----------------------|-----|-----|
| II: anchors placed parallel to horizontal joint     |  | $60^{1)}$     | $100^{1)}$    | $\alpha_{g,V,II}$    | [-] | 1,0 |
|                                                     |  | $c_{cr}$      | 250           |                      |     | 2,0 |
| ⊥: anchors placed perpendicular to horizontal joint |  | $60^{1)}$     | $100^{1)}$    | $\alpha_{g,V,\perp}$ |     | 1,6 |
|                                                     |  | $c_{cr}$      | 250           |                      |     | 2,0 |

<sup>1)</sup> Only valid for  $V_{Rk,b}$  according to Table C93 and C94 values in brackets

**Table C92: Group factor for anchor group in case of shear loading perpendicular to free edge**

| Configuration                                       |  | with $c \geq$ | with $s \geq$ |                      |     |     |
|-----------------------------------------------------|--|---------------|---------------|----------------------|-----|-----|
| II: anchors placed parallel to horizontal joint     |  | $60^{1)}$     | $100^{1)}$    | $\alpha_{g,V,II}$    | [-] | 1,0 |
|                                                     |  | $c_{cr}$      | 250           |                      |     | 2,0 |
| ⊥: anchors placed perpendicular to horizontal joint |  | $60^{1)}$     | $100^{1)}$    | $\alpha_{g,V,\perp}$ |     | 1,6 |
|                                                     |  | $c_{cr}$      | 250           |                      |     | 2,0 |

<sup>1)</sup> Only valid for  $V_{Rk,b}$  according to Table C93 and C94 values in brackets

**Table C93: Characteristic values of resistance under tension and shear loads**

| Anchor size                                                        | Sleeve | Effective anchorage depth | Characteristic resistance  |           |            |                           |
|--------------------------------------------------------------------|--------|---------------------------|----------------------------|-----------|------------|---------------------------|
|                                                                    |        |                           | Use category               |           |            |                           |
|                                                                    |        |                           | d/d; w/d; w/w              |           |            |                           |
|                                                                    |        |                           | 40°C/24°C                  | 80°C/50°C | 120°C/72°C | For all temperature range |
|                                                                    |        | $h_{ef}$                  | $N_{Rk,b} = N_{Rk,p}^{1)}$ |           |            | $V_{Rk,b}^{4)}$           |
|                                                                    |        | [mm]                      | [kN]                       |           |            |                           |
| <b>Compressive strength <math>f_b \geq 4 \text{ N/mm}^2</math></b> |        |                           |                            |           |            |                           |
| M8                                                                 | 12x80  | 80                        | 0,4                        | 0,4       | 0,3        | $2,0^{2)}$ ( $0,9^{3)}$   |
| M8 / M10 / IG-M6                                                   | 16x85  | 85                        |                            |           |            |                           |
|                                                                    | 16x130 | 130                       |                            |           |            |                           |
| M12 / M16 / IG-M8 / IG-M10                                         | 20x85  | 85                        |                            |           |            |                           |
|                                                                    | 20x130 | 130                       |                            |           |            |                           |
|                                                                    | 20x200 | 200                       |                            |           |            |                           |
| <b>Compressive strength <math>f_b \geq 6 \text{ N/mm}^2</math></b> |        |                           |                            |           |            |                           |
| M8                                                                 | 12x80  | 80                        | 0,5                        | 0,5       | 0,4        | $2,5^{2)}$ ( $1,2^{3)}$   |
| M8 / M10 / IG-M6                                                   | 16x85  | 85                        |                            |           |            |                           |
|                                                                    | 16x130 | 130                       |                            |           |            |                           |
| M12 / M16 / IG-M8 / IG-M10                                         | 20x85  | 85                        |                            |           |            |                           |
|                                                                    | 20x130 | 130                       |                            |           |            |                           |
|                                                                    | 20x200 | 200                       |                            |           |            |                           |

<sup>1)</sup> Values are valid for  $c_{cr}$  and  $c_{min}$

<sup>2)</sup> Calculation of  $V_{Rk,c}$  see Technical Report TR 054, except for shear load parallel to free edge with  $c \geq 125 \text{ mm}$ :  $V_{Rk,c,II} = V_{Rk,b}$

<sup>3)</sup> Values in brackets  $V_{Rk,c} = V_{Rk,b}$  for anchors with  $c_{min}$

<sup>4)</sup> The values are valid for steel 5.6 or greater. For steel 4.6 and 4.8 multiply  $V_{Rk,b}$  by 0,8

**ESSVE Injection system ONE, ONE ICE for masonry**

**Performances clay hollow brick Blocchi Leggeri**

Installation parameters (continue)

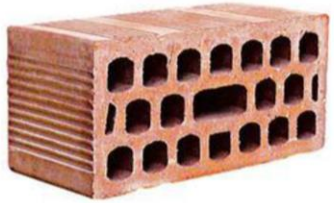
Characteristic values of resistance under tension and shear load

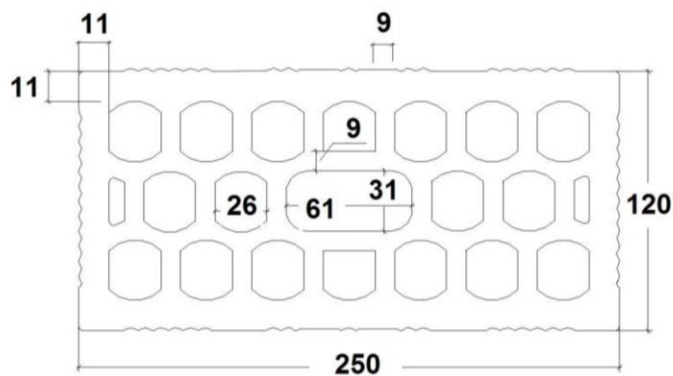
**Annex C 37**

| Brick type: Clay hollow brick Blocchi Leggeri                                                                                                                                                                                                                                                                                                                                                                                               |           |                                    |                           |                |               |                                       |                 |               |                    |
|---------------------------------------------------------------------------------------------------------------------------------------------------------------------------------------------------------------------------------------------------------------------------------------------------------------------------------------------------------------------------------------------------------------------------------------------|-----------|------------------------------------|---------------------------|----------------|---------------|---------------------------------------|-----------------|---------------|--------------------|
| Table C94: Characteristic values of resistance under tension and shear loads (continue)                                                                                                                                                                                                                                                                                                                                                     |           |                                    |                           |                |               |                                       |                 |               |                    |
| Anchor size                                                                                                                                                                                                                                                                                                                                                                                                                                 | Sleeve    | Effective anchorage depth          | Characteristic resistance |                |               |                                       |                 |               |                    |
|                                                                                                                                                                                                                                                                                                                                                                                                                                             |           |                                    | Use category              |                |               |                                       |                 |               |                    |
|                                                                                                                                                                                                                                                                                                                                                                                                                                             |           |                                    | d/d<br>w/d<br>w/w         |                |               |                                       |                 |               |                    |
|                                                                                                                                                                                                                                                                                                                                                                                                                                             |           |                                    | 40°C/24°C                 | 80°C/50°C      | 120°C/72°C    | For all temperature range             |                 |               |                    |
| $h_{ef}$                                                                                                                                                                                                                                                                                                                                                                                                                                    |           | $N_{Rk,b} = N_{Rk,D}^{1)}$         |                           |                |               |                                       | $V_{Rk,b}^{4)}$ |               |                    |
| [mm]                                                                                                                                                                                                                                                                                                                                                                                                                                        |           | [kN]                               |                           |                |               |                                       |                 |               |                    |
| Compressive strength $f_b \geq 8 \text{ N/mm}^2$                                                                                                                                                                                                                                                                                                                                                                                            |           |                                    |                           |                |               |                                       |                 |               |                    |
| M8                                                                                                                                                                                                                                                                                                                                                                                                                                          | 12x80     | 80                                 | 0,6                       | 0,6            | 0,5           | 3,0 <sup>2)</sup> (1,2) <sup>3)</sup> |                 |               |                    |
| M8 / M10 / IG-M6                                                                                                                                                                                                                                                                                                                                                                                                                            | 16x85     | 85                                 |                           |                |               |                                       |                 |               |                    |
|                                                                                                                                                                                                                                                                                                                                                                                                                                             | 16x130    | 130                                |                           |                |               |                                       |                 |               |                    |
| M12 / M16 / IG-M8 / IG-M10                                                                                                                                                                                                                                                                                                                                                                                                                  | 20x85     | 85                                 |                           |                |               |                                       |                 |               |                    |
|                                                                                                                                                                                                                                                                                                                                                                                                                                             | 20x130    | 130                                |                           |                |               |                                       |                 |               |                    |
|                                                                                                                                                                                                                                                                                                                                                                                                                                             | 20x200    | 200                                |                           |                |               |                                       |                 |               |                    |
| Compressive strength $f_b \geq 12 \text{ N/mm}^2$                                                                                                                                                                                                                                                                                                                                                                                           |           |                                    |                           |                |               |                                       |                 |               |                    |
| M8                                                                                                                                                                                                                                                                                                                                                                                                                                          | 12x80     | 80                                 | 0,6                       | 0,6            | 0,6           | 3,5 <sup>2)</sup> (1,5) <sup>3)</sup> |                 |               |                    |
| M8 / M10 / IG-M6                                                                                                                                                                                                                                                                                                                                                                                                                            | 16x85     | 85                                 |                           |                |               |                                       |                 |               |                    |
|                                                                                                                                                                                                                                                                                                                                                                                                                                             | 16x130    | 130                                |                           |                |               |                                       |                 |               |                    |
| M12 / M16 / IG-M8 / IG-M10                                                                                                                                                                                                                                                                                                                                                                                                                  | 20x85     | 85                                 |                           |                |               |                                       |                 |               |                    |
|                                                                                                                                                                                                                                                                                                                                                                                                                                             | 20x130    | 130                                |                           |                |               |                                       |                 |               |                    |
|                                                                                                                                                                                                                                                                                                                                                                                                                                             | 20x200    | 200                                |                           |                |               |                                       |                 |               |                    |
| <sup>1)</sup> Values are valid for $c_{cr}$ and $c_{min}$<br><sup>2)</sup> Calculation of $V_{Rk,c}$ see Technical Report TR 054, except for shear load parallel to free edge with $c \geq 125 \text{ mm}$ : $V_{Rk,c,II} = V_{Rk,b}$<br><sup>3)</sup> Values in brackets $V_{Rk,c} = V_{Rk,b}$ for anchors with $c_{min}$<br><sup>4)</sup> The values are valid for steel 5.6 or greater. For steel 4.6 and 4.8 multiply $V_{Rk,b}$ by 0,8 |           |                                    |                           |                |               |                                       |                 |               |                    |
| Table C95: Displacements                                                                                                                                                                                                                                                                                                                                                                                                                    |           |                                    |                           |                |               |                                       |                 |               |                    |
| Anchor size                                                                                                                                                                                                                                                                                                                                                                                                                                 | Sleeve    | Effective anchorage depth $h_{ef}$ | N                         | $\delta_N / N$ | $\delta_{N0}$ | $\delta_{N\infty}$                    | V               | $\delta_{V0}$ | $\delta_{V\infty}$ |
|                                                                                                                                                                                                                                                                                                                                                                                                                                             |           | [mm]                               | [kN]                      | [mm/kN]        | [mm]          | [mm]                                  | [kN]            | [mm]          | [mm]               |
| All sizes                                                                                                                                                                                                                                                                                                                                                                                                                                   | All sizes | All sizes                          | 0,17                      | 1,20           | 0,21          | 0,41                                  | 0,9             | 1,20          | 1,80               |
| ESSVE Injection system ONE, ONE ICE for masonry                                                                                                                                                                                                                                                                                                                                                                                             |           |                                    |                           |                |               |                                       | Annex C 38      |               |                    |
| <b>Performances clay hollow brick Blocchi Leggeri</b><br>Characteristic values of resistance under tension and shear load (continue)<br>Displacements                                                                                                                                                                                                                                                                                       |           |                                    |                           |                |               |                                       |                 |               |                    |

**Brick type: Clay hollow brick Doppio Uni**

**Table C96: Description of the brick**

|                                                      |                              |                                                                                     |
|------------------------------------------------------|------------------------------|-------------------------------------------------------------------------------------|
| Brick type                                           | Clay hollow brick Doppio Uni |  |
| Bulk density $\rho$ [kg/dm <sup>3</sup> ]            | 0,9                          |                                                                                     |
| Compressive strength $f_b \geq$ [N/mm <sup>2</sup> ] | 10, 16, 20 or 28             |                                                                                     |
| Code                                                 | EN 771-1                     |                                                                                     |
| Producer (country code)                              | e.g. Wienerberger (IT)       |                                                                                     |
| Brick dimensions [mm]                                | 250 x 120 x 120              |                                                                                     |
| Drilling method                                      | Rotary                       |                                                                                     |



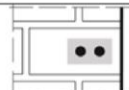
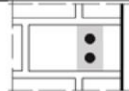
**Table C97: Installation parameters**

| Anchor size           |                         | [-]  | All sizes               |
|-----------------------|-------------------------|------|-------------------------|
| Edge distance         | $C_{cr}$                | [mm] | 100 (120) <sup>1)</sup> |
| Minimum edge distance | $C_{min}$ <sup>2)</sup> | [mm] | 60                      |
| Spacing               | $S_{cr,II}$             | [mm] | 250                     |
|                       | $S_{cr,\perp}$          | [mm] | 120                     |
| Minimum spacing       | $S_{min,II}$            | [mm] | 100                     |
|                       | $S_{min,\perp}$         | [mm] | 120                     |

<sup>1)</sup> Value in brackets for SH20x85; SH20x130 and SH20x200

<sup>2)</sup> For  $V_{Rk,c}$ :  $C_{min}$  according to Technical Report TR 054

**Table C98: Group factor for anchor group in case of tension loading**

| Configuration                                              |                                                                                     | with $c \geq$ | with $s \geq$ |                      |     |     |
|------------------------------------------------------------|-------------------------------------------------------------------------------------|---------------|---------------|----------------------|-----|-----|
| II: anchors placed parallel to horizontal joint            |  | 60            | 100           | $\alpha_{g,N,II}$    | [-] | 1,0 |
|                                                            |                                                                                     | $C_{cr}$      | 250           |                      |     | 2,0 |
| $\perp$ : anchors placed perpendicular to horizontal joint |  | 60            | 120           | $\alpha_{g,N,\perp}$ |     | 2,0 |

**ESSVE Injection system ONE, ONE ICE for masonry**

**Performances clay hollow brick Doppio Uni**

Description of the brick  
Installation parameters

**Annex C 39**



**Brick type: Clay hollow brick Doppio Uni**

**Table C99: Group factor for anchor group in case of shear loading parallel to free edge**

| Configuration                                       |  | with $c \geq$ | with $s \geq$ |                      |     |     |
|-----------------------------------------------------|--|---------------|---------------|----------------------|-----|-----|
| II: anchors placed parallel to horizontal joint     |  | $C_{Cr}$      | 250           | $\alpha_{g,V,II}$    | [-] | 2,0 |
| ⊥: anchors placed perpendicular to horizontal joint |  | $C_{Cr}$      | 120           | $\alpha_{g,V,\perp}$ |     | 2,0 |

**Table C100: Group factor for anchor group in case of shear loading perpendicular to free edge**

| Configuration                                       |  | with $c \geq$ | with $s \geq$ |                      |     |     |
|-----------------------------------------------------|--|---------------|---------------|----------------------|-----|-----|
| II: anchors placed parallel to horizontal joint     |  | $C_{Cr}$      | 250           | $\alpha_{g,V,II}$    | [-] | 2,0 |
| ⊥: anchors placed perpendicular to horizontal joint |  | $C_{Cr}$      | 120           | $\alpha_{g,V,\perp}$ |     | 2,0 |

**Table C101: Characteristic values of resistance under tension and shear loads**

| Anchor size                                                         | Sleeve | Effective anchorage depth | Characteristic resistance  |           |            |                           |
|---------------------------------------------------------------------|--------|---------------------------|----------------------------|-----------|------------|---------------------------|
|                                                                     |        |                           | Use category               |           |            |                           |
|                                                                     |        |                           | d/d<br>w/d<br>w/w          |           |            |                           |
|                                                                     |        |                           | 40°C/24°C                  | 80°C/50°C | 120°C/72°C | For All temperature range |
|                                                                     |        | $h_{ef}$                  | $N_{Rk,b} = N_{Rk,p}^{1)}$ |           |            | $V_{Rk,b}^{2)3)}$         |
|                                                                     |        | [mm]                      | [kN]                       |           |            |                           |
| <b>Compressive strength <math>f_b \geq 10 \text{ N/mm}^2</math></b> |        |                           |                            |           |            |                           |
| M8                                                                  | 12x80  | 80                        | 0,6                        | 0,6       | 0,5        | 1,5                       |
| M8 / M10 / IG-M6                                                    | 16x85  | 85                        |                            |           |            |                           |
|                                                                     | 16x130 | 130                       |                            |           |            |                           |
| M12 / M16 / IG-M8 / IG-M10                                          | 20x85  | 85                        |                            |           |            |                           |
|                                                                     | 20x130 | 130                       |                            |           |            |                           |
|                                                                     | 20x200 | 200                       |                            |           |            |                           |
| <b>Compressive strength <math>f_b \geq 16 \text{ N/mm}^2</math></b> |        |                           |                            |           |            |                           |
| M8                                                                  | 12x80  | 80                        | 0,75                       | 0,75      | 0,6        | 2,0                       |
| M8 / M10 / IG-M6                                                    | 16x85  | 85                        |                            |           |            |                           |
|                                                                     | 16x130 | 130                       |                            |           |            |                           |
| M12 / M16 / IG-M8 / IG-M10                                          | 20x85  | 85                        |                            |           |            |                           |
|                                                                     | 20x130 | 130                       |                            |           |            |                           |
|                                                                     | 20x200 | 200                       |                            |           |            |                           |

1) Values are valid for  $c_{Cr}$  and  $c_{min}$

2) Calculation of  $V_{Rk,c}$  see Technical Report TR 054

3) The values are valid for steel 5.6 or greater. For steel 4.6 and 4.8 multiply  $V_{Rk,b}$  by 0,8

**ESSVE Injection system ONE, ONE ICE for masonry**

**Performances clay hollow brick Doppio Uni**

Installation parameters (continue)

Characteristic values of resistance under tension and shear load

**Annex C 40**

**Brick type: Clay hollow brick Doppio Uni**

**Table C102: Characteristic values of resistance under tension and shear loads (continue)**

| Anchor size                                                         | Sleeve                     | Effective anchorage depth | Characteristic resistance |                   |            |                           |
|---------------------------------------------------------------------|----------------------------|---------------------------|---------------------------|-------------------|------------|---------------------------|
|                                                                     |                            |                           | Use category              |                   |            |                           |
|                                                                     |                            |                           | d/d<br>w/d<br>w/w         |                   |            |                           |
|                                                                     |                            |                           | 40°C/24°C                 | 80°C/50°C         | 120°C/72°C | For All temperature range |
| $h_{ef}$                                                            | $N_{Rk,b} = N_{Rk,d}^{1)}$ |                           |                           | $V_{Rk,b}^{2)3)}$ |            |                           |
| [mm]                                                                | [kN]                       |                           |                           |                   |            |                           |
| <b>Compressive strength <math>f_b \geq 20 \text{ N/mm}^2</math></b> |                            |                           |                           |                   |            |                           |
| M8                                                                  | 12x80                      | 80                        | 0,9                       | 0,9               | 0,75       | 2,0                       |
| M8 / M10/<br>IG-M6                                                  | 16x85                      | 85                        |                           |                   |            |                           |
|                                                                     | 16x130                     | 130                       |                           |                   |            |                           |
| M12 / M16 /<br>IG-M8 / IG-M10                                       | 20x85                      | 85                        |                           |                   |            |                           |
|                                                                     | 20x130                     | 130                       |                           |                   |            |                           |
|                                                                     | 20x200                     | 200                       |                           |                   |            |                           |
| <b>Compressive strength <math>f_b \geq 28 \text{ N/mm}^2</math></b> |                            |                           |                           |                   |            |                           |
| M8                                                                  | 12x80                      | 80                        | 1,2                       | 1,2               | 0,9        | 2,5                       |
| M8 / M10/<br>IG-M6                                                  | 16x85                      | 85                        |                           |                   |            |                           |
|                                                                     | 16x130                     | 130                       |                           |                   |            |                           |
| M12 / M16 /<br>IG-M8 / IG-M10                                       | 20x85                      | 85                        |                           |                   |            |                           |
|                                                                     | 20x130                     | 130                       |                           |                   |            |                           |
|                                                                     | 20x200                     | 200                       |                           |                   |            |                           |

1) Values are valid for  $c_{cr}$  and  $c_{min}$

2) Calculation of  $V_{Rk,c}$  see Technical Report TR 054

3) The values are valid for steel 5.6 or greater. For steel 4.6 and 4.8 multiply  $V_{Rk,b}$  by 0,8

**Table C103: Displacements**

| Anchor size | Sleeve    | Effective anchorage depth $h_{ef}$ | N    | $\delta_N / N$ | $\delta_{N0}$ | $\delta_{N\infty}$ | V    | $\delta_{V0}$ | $\delta_{V\infty}$ |
|-------------|-----------|------------------------------------|------|----------------|---------------|--------------------|------|---------------|--------------------|
|             |           |                                    | [kN] | [mm/kN]        | [mm]          | [mm]               | [kN] | [mm]          | [mm]               |
| All sizes   | All sizes | All sizes                          | 0,26 | 1,20           | 0,31          | 0,62               | 0,6  | 0,3           | 0,45               |

**ESSVE Injection system ONE, ONE ICE for masonry**

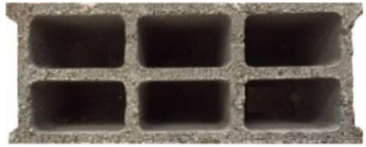
**Performances clay hollow brick Doppio Uni**

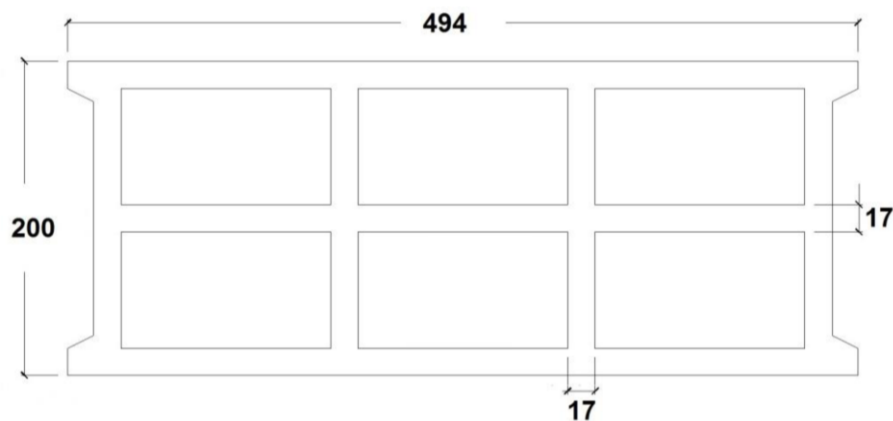
Characteristic values of resistance under tension and shear load (continue)  
Displacements

**Annex C 41**

**Brick type: Hollow Light weight concrete Bloc creux B40**

**Table C104: Description of the brick**

|                                                      |                                                |                                                                                     |
|------------------------------------------------------|------------------------------------------------|-------------------------------------------------------------------------------------|
| Brick type                                           | Hollow light weight concrete<br>Bloc creux B40 |  |
| Bulk density $\rho$ [kg/dm <sup>3</sup> ]            | 0,8                                            |                                                                                     |
| Compressive strength $f_b \geq$ [N/mm <sup>2</sup> ] | 4                                              |                                                                                     |
| Code                                                 | EN 771-3                                       |                                                                                     |
| Producer (country code)                              | e.g. Sepa (FR)                                 |                                                                                     |
| Brick dimensions [mm]                                | 494 x 200 x 190                                |                                                                                     |
| Drilling method                                      | Rotary                                         |                                                                                     |



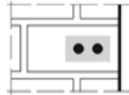

**Table C105: Installation parameters**

| Anchor size           |                         | [-]  | All sizes               |
|-----------------------|-------------------------|------|-------------------------|
| Edge distance         | $C_{cr}$                | [mm] | 100 (120) <sup>1)</sup> |
| Minimum edge distance | $C_{min}$ <sup>2)</sup> | [mm] | 100 (120) <sup>1)</sup> |
| Spacing               | $S_{cr,II}$             | [mm] | 494                     |
|                       | $S_{cr,\perp}$          | [mm] | 190                     |
| Minimum spacing       | $S_{min}$               | [mm] | 100                     |

<sup>1)</sup> Value in brackets for SH20x85 and SH20x130

<sup>2)</sup> For  $V_{Rk,c}$ :  $C_{min}$  according to Technical Report TR 054

**Table C106: Group factor for anchor group in case of tension loading**

| Configuration                                       |                                                                                     | with $c \geq$ | with $s \geq$ | $\alpha_{g,N,II}$    | [-] |     |
|-----------------------------------------------------|-------------------------------------------------------------------------------------|---------------|---------------|----------------------|-----|-----|
| II: anchors placed parallel to horizontal joint     |  | 100           | 100           |                      |     |     |
|                                                     |                                                                                     | $C_{cr}$      | 494           | 2,0                  |     |     |
| ⊥: anchors placed perpendicular to horizontal joint |  | 100           | 100           | $\alpha_{g,N,\perp}$ |     | 1,0 |
|                                                     |                                                                                     | $C_{cr}$      | 190           |                      |     | 2,0 |

**ESSVE Injection system ONE, ONE ICE for masonry**

**Performances hollow light weight concrete Bloc creux B40**

Description of the brick  
Installation parameters

**Annex C 42**

**Brick type: Hollow Light weight concrete Bloc creux B40**

**Table C107: Group factor for anchor group in case of shear loading parallel to free edge**

| Configuration                                       |  | with $c \geq$ | with $s \geq$ |                      |     |     |
|-----------------------------------------------------|--|---------------|---------------|----------------------|-----|-----|
| II: anchors placed parallel to horizontal joint     |  | 50            | 100           | $\alpha_{g,V,II}$    | [-] | 1,1 |
|                                                     |  | $c_{cr}$      | 494           |                      |     | 2,0 |
| ⊥: anchors placed perpendicular to horizontal joint |  | 100           | 100           | $\alpha_{g,V,\perp}$ | [-] | 1,1 |
|                                                     |  | $c_{cr}$      | 190           |                      |     | 2,0 |

**Table C108: Group factor for anchor group in case of shear loading perpendicular to free edge**

| Configuration                                   |  | with $c \geq$ | with $s \geq$ |                   |     |                      |
|-------------------------------------------------|--|---------------|---------------|-------------------|-----|----------------------|
| II: anchors placed parallel to horizontal joint |  | $c_{cr}$      | 494           | $\alpha_{g,V,II}$ | [-] | 2,0                  |
|                                                 |  | $c_{cr}$      | 190           |                   |     | $\alpha_{g,V,\perp}$ |

**Table C109: Characteristic values of resistance under tension and shear loads**

| Anchor size                                                        | Sleeve | Effective anchorage depth | Characteristic resistance  |           |            |                            |           |            |                           |                   |
|--------------------------------------------------------------------|--------|---------------------------|----------------------------|-----------|------------|----------------------------|-----------|------------|---------------------------|-------------------|
|                                                                    |        |                           | Use category               |           |            |                            |           |            |                           |                   |
|                                                                    |        |                           | d/d                        |           |            | w/d                        |           |            | d/d                       |                   |
|                                                                    |        |                           | 40°C/24°C                  | 80°C/50°C | 120°C/72°C | 40°C/24°C                  | 80°C/50°C | 120°C/72°C | w/d                       |                   |
|                                                                    |        | $h_{ef}$                  | $N_{Rk,b} = N_{Rk,p}^{1)}$ |           |            | $N_{Rk,b} = N_{Rk,p}^{1)}$ |           |            | For all temperature range |                   |
|                                                                    |        | [mm]                      | [kN]                       |           |            |                            |           |            |                           | $V_{Rk,b}^{2)3)}$ |
| <b>Compressive strength <math>f_b \geq 4 \text{ N/mm}^2</math></b> |        |                           |                            |           |            |                            |           |            |                           |                   |
| M8                                                                 | 12x80  | 80                        | 1,2                        | 0,9       | 0,75       | 0,9                        | 0,9       | 0,75       | 3,0                       |                   |
| M8 / M10 / IG-M6                                                   | 16x85  | 85                        | 1,2                        | 0,9       | 0,75       | 1,2                        | 0,9       | 0,75       | 3,0                       |                   |
|                                                                    | 16x130 | 130                       | 1,2                        | 0,9       | 0,75       | 1,2                        | 0,9       | 0,75       | 3,0                       |                   |
| M12 / M16 / IG-M8 / IG-M10                                         | 20x85  | 85                        | 1,2                        | 0,9       | 0,75       | 1,2                        | 0,9       | 0,75       | 3,0                       |                   |
|                                                                    | 20x130 | 130                       | 1,2                        | 0,9       | 0,75       | 1,2                        | 0,9       | 0,75       | 3,0                       |                   |

1) Values are valid for  $c_{cr}$  and  $c_{min}$

2) Calculation of  $V_{Rk,c}$  see Technical Report TR 054, except for shear load parallel to free edge with  $c \geq 250 \text{ mm}$ :  $V_{Rk,c,II} = V_{Rk,b}$

3) The values are valid for steel 5.6 or greater. For steel 4.6 and 4.8 multiply  $V_{Rk,b}$  by 0,8

**Table C110: Displacements**

| Anchor size | Sleeve    | Effective anchorage depth $h_{ef}$ | N    | $\delta_N / N$ | $\delta_{N0}$ | $\delta_{N\infty}$ | V    | $\delta_{V0}$ | $\delta_{V\infty}$ |
|-------------|-----------|------------------------------------|------|----------------|---------------|--------------------|------|---------------|--------------------|
|             |           |                                    | [kN] | [mm/kN]        | [mm]          | [mm]               | [kN] | [mm]          | [mm]               |
| All sizes   | All sizes | All sizes                          | 0,34 | 0,90           | 0,31          | 0,62               | 0,86 | 0,9           | 1,35               |

**ESSVE Injection system ONE, ONE ICE for masonry**

**Performances hollow light weight concrete brick Bloc creux B40**


Installation parameters (continue)

Characteristic values of resistance under tension and shear load / Displacements

**Annex C 43**

**Brick type: Solid light weight concrete brick - LAC**

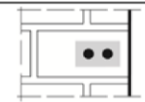
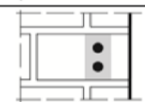
**Table C111: Description of the brick**

|                                                      |                                   |  |                                                                                     |
|------------------------------------------------------|-----------------------------------|--|-------------------------------------------------------------------------------------|
| Brick type                                           | Solid light weight concrete brick |  |  |
| Bulk density $\rho$ [kg/dm <sup>3</sup> ]            | 0,6                               |  |                                                                                     |
| Compressive strength $f_b \geq$ [N/mm <sup>2</sup> ] | 2                                 |  |                                                                                     |
| Code                                                 | EN 771-3                          |  |                                                                                     |
| Producer (country code)                              | e.g. Bisotherm (DE)               |  |                                                                                     |
| Brick dimensions [mm]                                | 300 x 123 x 248                   |  |                                                                                     |
| Drilling method                                      | Rotary                            |  |                                                                                     |

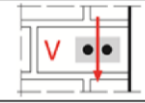
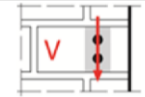
**Table C112: Installation parameter**

|                       |           |      |                    |
|-----------------------|-----------|------|--------------------|
| Anchor size           |           | [-]  | All sizes          |
| Edge distance         | $c_{cr}$  | [mm] | $1,5 \cdot h_{ef}$ |
| Minimum edge distance | $c_{min}$ | [mm] | 60                 |
| Spacing               | $s_{cr}$  | [mm] | $3 \cdot h_{ef}$   |
| Minimum spacing       | $s_{min}$ | [mm] | 120                |

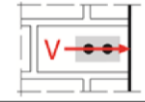
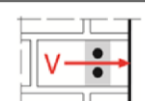
**Table C113: Group factor for anchor group in case of tension loading**

| Configuration                                                                                                                              |  | with $c \geq$      | with $s \geq$    |                      |     |     |
|--------------------------------------------------------------------------------------------------------------------------------------------|--|--------------------|------------------|----------------------|-----|-----|
| II: anchors placed parallel to horizontal joint<br>     |  | 90                 | 120              | $\alpha_{g,N,II}$    | [-] | 1,1 |
|                                                                                                                                            |  | $1,5 \cdot h_{ef}$ | $3 \cdot h_{ef}$ |                      |     | 2,0 |
| ⊥: anchors placed perpendicular to horizontal joint<br> |  | 124                | 120              | $\alpha_{g,N,\perp}$ |     | 1,1 |
|                                                                                                                                            |  | $1,5 \cdot h_{ef}$ | $3 \cdot h_{ef}$ |                      |     | 2,0 |

**Table C114: Group factor for anchor group in case of shear loading parallel to free edge**

| Configuration                                                                                                                              |  | with $c \geq$ | with $s \geq$ |                      |     |     |
|--------------------------------------------------------------------------------------------------------------------------------------------|--|---------------|---------------|----------------------|-----|-----|
| II: anchors placed parallel to horizontal joint<br>     |  | 60            | 120           | $\alpha_{g,V,II}$    | [-] | 0,6 |
|                                                                                                                                            |  | 90            | 120           |                      |     | 2,0 |
| ⊥: anchors placed perpendicular to horizontal joint<br> |  | 60            | 120           | $\alpha_{g,V,\perp}$ |     | 0,6 |
|                                                                                                                                            |  | 124           | 120           |                      |     | 2,0 |

**Table C115: Group factor for anchor group in case of shear loading perpendicular to free edge**

| Configuration                                                                                                                              |  | with $c \geq$      | with $s \geq$    |                      |     |     |
|--------------------------------------------------------------------------------------------------------------------------------------------|--|--------------------|------------------|----------------------|-----|-----|
| II: anchors placed parallel to horizontal joint<br>     |  | 60                 | 120              | $\alpha_{g,V,II}$    | [-] | 0,6 |
|                                                                                                                                            |  | 90                 | 120              |                      |     | 2,0 |
| ⊥: anchors placed perpendicular to horizontal joint<br> |  | 60                 | 120              | $\alpha_{g,V,\perp}$ |     | 0,6 |
|                                                                                                                                            |  | $1,5 \cdot h_{ef}$ | 120              |                      |     | 1,0 |
|                                                                                                                                            |  | $1,5 \cdot h_{ef}$ | $3 \cdot h_{ef}$ |                      | 2,0 |     |

**ESSVE Injection system ONE, ONE ICE for masonry**

**Performances solid light weight concrete brick - LAC**

Description of the brick  
Installation parameters

**Annex C 44**

**Brick type: Solid light weight concrete brick - LAC**

**Table C116: Characteristic values of resistance under tension and shear loads**

| Anchor size                                      | Sleeve                     | Effective anchorage depth | Characteristic resistance |                            |            |            |                   |            |                           |
|--------------------------------------------------|----------------------------|---------------------------|---------------------------|----------------------------|------------|------------|-------------------|------------|---------------------------|
|                                                  |                            |                           | Use category              |                            |            |            |                   |            |                           |
|                                                  |                            |                           | d/d                       |                            |            | w/d<br>w/w |                   |            | d/d<br>w/d<br>w/w         |
|                                                  |                            |                           | 40°C/24°C                 | 80°C/50°C                  | 120°C/72°C | 40°C/24°C  | 80°C/50°C         | 120°C/72°C | For all temperature range |
| $h_{ef}$                                         | $N_{Rk,b} = N_{Rk,p}^{1)}$ |                           |                           | $N_{Rk,b} = N_{Rk,p}^{1)}$ |            |            | $V_{Rk,b}^{2)3)}$ |            |                           |
| [mm]                                             | [kN]                       |                           |                           |                            |            |            |                   |            |                           |
| Compressive strength $f_b \geq 2 \text{ N/mm}^2$ |                            |                           |                           |                            |            |            |                   |            |                           |
| M8                                               | -                          | 80                        | 3,0                       | 2,5                        | 2,0        | 2,5        | 2,0               | 1,5        | 3,0                       |
| M8 / M10/<br>IG-M6                               | -                          | 90                        | 3,0                       | 3,0                        | 2,0        | 2,5        | 2,5               | 2,0        | 3,0                       |
| M10 /<br>IG-M8                                   | -                          | 100                       | 3,5                       | 3,0                        | 2,5        | 3,0        | 2,5               | 2,0        | 3,0                       |
| M16 /<br>IG-M10                                  | -                          | 100                       | 3,0                       | 3,0                        | 2,0        | 3,0        | 3,0               | 2,0        | 3,0                       |
| M8                                               | 12x80                      | 80                        | 2,5                       | 2,5                        | 2,0        | 2,5        | 2,0               | 1,5        | 3,0                       |
| M8 / M10/<br>IG-M6                               | 16x85                      | 85                        | 3,0                       | 2,5                        | 2,0        | 3,0        | 2,5               | 2,0        | 3,0                       |
|                                                  | 16x130                     | 130                       | 3,0                       | 2,5                        | 2,0        | 3,0        | 2,5               | 2,0        | 3,0                       |
| M12 / M16<br>/ IG-M8 /<br>IG-M10                 | 20x85                      | 85                        | 2,5                       | 2,5                        | 2,0        | 2,5        | 2,5               | 2,0        | 3,0                       |
|                                                  | 20x130                     | 130                       | 2,5                       | 2,5                        | 2,0        | 2,5        | 2,5               | 2,0        | 3,0                       |
|                                                  | 20x200                     | 200                       | 2,5                       | 2,5                        | 2,0        | 2,5        | 2,5               | 2,0        | 3,0                       |

<sup>1)</sup> Values are valid for  $c_{Cr}$ , values in brackets are valid for single anchors with  $c_{min}$

<sup>2)</sup> For calculation of  $V_{Rk,c}$  see ETAG029, Annex C

<sup>3)</sup> The values are valid for steel 5.6 or greater. For steel 4.6 and 4.8 multiply  $V_{Rk,b}$  by 0,8

**Table C117: Displacements**

| Anchor size                   | Sleeve | Effective anchorage depth $h_{ef}$ | N    | $\delta_N / N$ | $\delta_{N0}$ | $\delta_{N\infty}$ | V    | $\delta_{V0}$ | $\delta_{V\infty}$ |
|-------------------------------|--------|------------------------------------|------|----------------|---------------|--------------------|------|---------------|--------------------|
|                               |        |                                    | [kN] | [mm/kN]        | [mm]          | [mm]               | [kN] | [mm]          | [mm]               |
| M8                            | -      | 80                                 | 0,86 | 0,50           | 0,43          | 0,86               | 0,9  | 0,25          | 0,38               |
| M8 / M10/<br>IG-M6            | -      | 90                                 |      |                |               |                    |      |               |                    |
| M10 / IG-M8                   | -      | 100                                |      |                |               |                    |      |               |                    |
| M16 / IG-M10                  | -      | 100                                | 0,35 | 0,35           | 0,70          |                    |      |               |                    |
| M8                            | 12x80  | 80                                 | 0,71 | 0,35           | 0,25          | 0,50               |      |               |                    |
| M8 / M10/<br>IG-M6            | 16x85  | 85                                 |      |                |               |                    |      |               |                    |
|                               | 16x130 | 130                                |      |                |               |                    |      |               |                    |
| M12 / M16 /<br>IG-M8 / IG-M10 | 20x85  | 85                                 |      |                |               |                    |      |               |                    |
|                               | 20x130 | 130                                |      |                |               |                    |      |               |                    |
|                               | 20x200 | 200                                |      |                |               |                    |      |               |                    |

**ESSVE Injection system ONE, ONE ICE for masonry**

**Performances solid light weight concrete brick - LAC**  
Characteristic values of resistance under tension and shear load  
Displacements

**Annex C 45**